





## LADDERS FROM PAGE 8

## ACCESSES FROM PAGE 32

## ROLLING TOWERS FROM PAGE 46



Single ladders	9
Double ladders	14
Multifunction ladders	19
Alu telescopic stage	21
Working platform	22
Aluminium steps	23
Wooden steps	24
Accessories	26
Spare parts	28
Roof ladders	30

Accesses	32
Start-stairway	35
Stairways	36
Stairways with platform	38
Maintenance platforms	40
Bridging stairways	42
Accessories	44

Rolling tower configurator	48
Amendment of standard DIN EN 1004	50
Safety structure P2	52
SoloTower	54
Zifa	60
Uni light	66
Uni compact	76
Uni standard	84
Uni wide	94
Uni Comfort	102
Staro rolling tower	106
Extension and spare parts	114



## ALU BRIDGING BEAM FROM PAGE 106

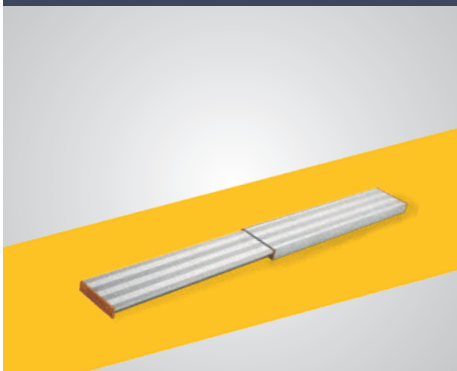

Telescopic Stages	21 or 106
Alu bridging beam	106

## NOTICE

All dimensions and weights are guideline values.  
Component weights are subject to fluctuations due to tolerances and may therefore diverge from what is specified. Subject to technical modification.

Our deliveries shall be made exclusively in accordance with our currently valid General Terms of Sale. These include the following provisions:

- ▶ The place of performance is Gueglingen-Eibensbach.
- ▶ Title to the delivered goods shall be retained until full payment has been made.

The fully GTC you can find here: [gtc.layher.com](http://gtc.layher.com)

Steel components are hot-dip galvanized according to EN ISO 1461 and DAST guideline 022.  
Connection parts or other small pieces can be galvanized according to EN ISO 4042.

Please request the specific instructions for assembly and use when ordering. Protected by copyright. Not to be reproduced, either in whole or in part. Misprints and errors excepted.



Further information for assembly and use. Just scan the QR Code.



Further Information, you can find in the Layher Info. Just scan the QR Code.



Further information, you can find in the product film. Just scan the QR Code.



Further information, you can find in the software. Just scan the QR Code.

# MADE IN GERMANY – MADE BY LAYHER



Headquarters in Eibensbach



Plant 2 in Gueglingen

## QUALITY MADE IN GERMANY.

Quality made by Layher comes from Gueglingen-Eibensbach. Our company has set down deep local roots since it was established. Right up until today, development, production, logistics and management are all in one place. Proximity to development, logistics and administration creates benefits to our customers around the world: short ways, short response times, controlled quality and manufacturing. The production can be adapted to the requirements at short notice and to the needs of the customers.

## SIMPLY SAFE. THE ACCESS SOLUTIONS.

This brand promise made by Layher is the expression of a brand philosophy that we've been living by for over 75 years. Quality assurance, future-proofing, delivery-securing, operational safety and long-lasting partnership are advantages that can be used to extend or increase your business opportunities and success in the long term. With comprehensive services, a permanent range of training courses and an ethos of customer focus, more than 1,900 dedicated Layher employees are creating more possibilities for our customers every single day. In 45 countries all over the world.

## SUSTAINABILITY AT LAYHER.

We've long been acting with a clear focus, with a view to both economic and ecological sustainability in all our process steps. Social responsibility towards employees, clients and society as a whole are at the very centre of this. We're a dependable employer, active in protecting our resources. The sparing use of work materials as a feature of our sustainable approach is fundamental to how we see ourselves: we already take care to ensure sustainable building methods when planning a new production facility, for example by greening the roofs or using photovoltaic systems. We also value locations that are close by, avoiding unnecessary CO<sub>2</sub> emissions due to long traffic routes. The topic of sustainability is firmly embedded in Layher's organisational structure thanks to its energy management team. Their work has paid off in particular in the form of DIN EN ISO 50001 certification.



Discover the world of Layher in its company film at:  
[yt-image-en.layher.com](http://yt-image-en.layher.com)





### MORE SPEED

High level of material availability, effective delivery service and quick assembly and dismantling of the scaffolding systems thanks to 100% fitting accuracy.

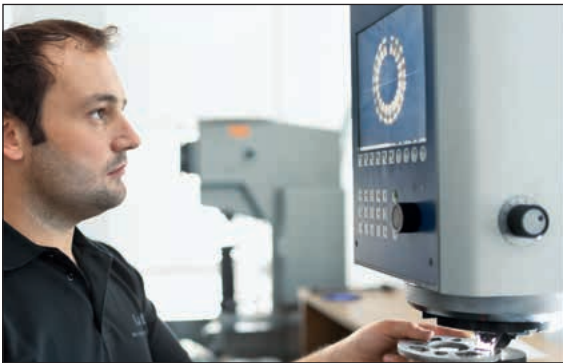

### MORE SAFETY

Outstanding quality and precision coupled with a long service life – confirmed internationally through independent certifications, inspections and approvals. Continuity and long-term partnership.

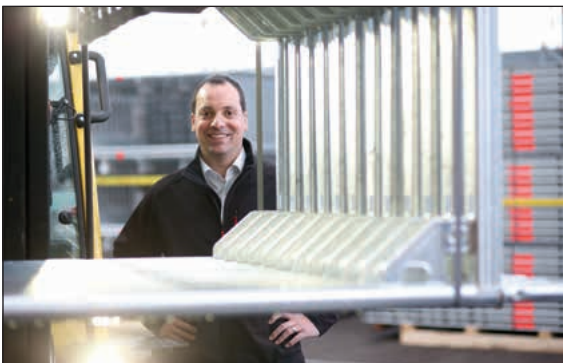

### MORE PROXIMITY

Comprehensive personal consultation and close-knit delivery network. Global presence through our own subsidiaries. Family-owned company that works closely with its customers.



### MORE SIMPLICITY

Economical scaffolding systems that have been proven in practice, available with an extensive product range. Cross-system combinations for versatile use. Rapid decision making thanks to efficient structures and processes.



### MORE FUTURE

Thanks to permanent product innovations and the improvement of existing parts. By opening up new areas of business. With an integrated system to ensure high profitability and retention of investment value. Through an extensive range of training opportunities and seminars to ensure that customers are always right up-to-date with the latest technical and commercial developments.

Layher Lightweight: Through the use of high-tensile steel, a new production process, and an improved design, we have succeeded in minimising the weight of the core components of our systems – while maintaining or raising load-bearing capacity.

# REQUIREMENTS OF THE DIN EN 131

## DIN EN 131-1

With effect from 1 January 2018, extensive amendments to the standard will come into force for ladders used in the commercial field as simple ladders and will require a cross-piece for simple ladders with a length of 3 metres and above. This also includes multi-function ladders usable as simple ladders. The width of the cross-piece is proportionate to the ladder length and to the external width of the ladder, widening as the ladder length increases.

**What does that mean for dealers?** As a general principle your warehouse stocks are protected. You can still sell the ladders you purchased prior to 1 January 2018 without cross-pieces.

- ▶ Layher recommends however that simple ladders be immediately modified to comply with the current standard in accordance with DIN EN 131-1.
- ▶ Even multifunctional ladders such as the Layher telescopic ladder *TOPIC* 1058 must have a base widening in the lean-to position.

**What does that mean for end users?** Commercial users can use their simple ladders without cross-pieces until the next scheduled ladder inspection. After that, the ladders must be upgraded to conform to the new standard (i.e. with cross-pieces).

- ▶ Layher ladders are, thanks to the Combigrip ladder foot, simple to equip with cross-pieces so that they conform to the valid standard.

## DIN EN 131-2

All ladders will be categorised as commercial-use or private-use-only ladders. This categorisation is based on a differing basic load during individual tests on the ladders (2250 N to 2700 N). Furthermore, 'durability test for double ladders', 'slip resistance test on floors for simple ladders', 'stability test of simple ladders with lateral stabilisation devices' and 'twisting test for simple ladders' have been added. The purpose of these additional tests is to improve the stability and safety of the products when in use. Ladders approved for commercial use may be used in private households too.

**What does that mean for dealers?** When selling the ladders, the intended use (private or commercial purposes) must be borne in mind. The approved application is identified by the following pictograms.

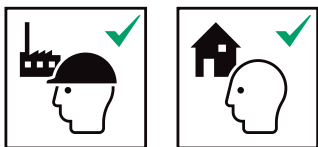

- ▶ All Layher ladders meet, without exception, the requirements for commercial use and hence also for private use.

**What does that mean for end users?** In the commercial field, only ladders approved for that purpose and identified by appropriate pictograms may be used.

- ▶ All Layher ladders meet, without exception, the requirements for commercial use and hence also for private use.

## DIN EN 131-3

Since September 1, 2018 user information (instructions for assembly and use) must be supplied in printed form with every ladder. The label must now show the precisely specified DIN pictograms.

**What does that mean for dealers?** Since September 1, 2018 instructions for assembly and use must be supplied with every ladder sold. This must be forwarded by the dealer to the customer.

- ▶ Layher will implement this requirement starting on the date specified to do so. Instructions for assembly and use will then be enclosed ex works in the ladder packaging. Alternatively, they can be downloaded for printout in the 'Mediathek' at [downloads.layher.com](https://downloads.layher.com) free of charge.

**What does that mean for end users?** The instructions for assembly and use must be kept to hand during use of the ladder.

## DIN EN 131-4

Since September 2020 the amendments to standard DIN EN 131-4 apply. This means that multi-purpose ladders like the Layher car boot ladder *TOPIC* 1057.112 with 4x3 rungs, which can be used as a work platform, must be delivered by the manufacturer including matching platforms.

- ▶ Layher Steigtechnik is offering with immediate effect a simple, high-quality and economical solution: the car boot ladder 4x3 including platform with reference number 1057.043 as a KIT – consisting of car boot ladder *TOPIC* 1057 and platform.
- ▶ The telescopic ladder *TOPIC* 1058 with base widening, Ref. no. 1016.175 corresponds to latest version of the DIN EN 131-4.

**What does that mean for customers and end users?**

- ▶ After the new DIN EN 131-4 has come into effect, dealers may continue to sell ladders in stock that were produced in accordance with the previous standard.
- ▶ After the new DIN EN 131-4 has come into effect, customers may also continue to use already purchased ladders that were produced in accordance with the previous standard until the next scheduled ladder inspection.

## LADDER EXAMINATION

- ▶ Every Layher ladder will be examined before leaving the plant.
- ▶ Please note the date the next examination on the ladder label (depending on the quantity of uses).
- ▶ Layher recommends an annual examination.
- ▶ The examination must be documented and archived and must be performed by a qualified person.

# SAFER WORKING IN ACCORDANCE WITH TRBS 2121-2

## FOR MORE SAFETY AT THE WORKPLACE

TRBS 2121-2 are technical rules for operating safety that govern the commercial use of ladders. They are not separate legal regulations. They specify, within the scope of their application, the requirements of the German Ordinance on Industrial Safety and Health. By compliance with these Technical Rules, contractors / commercial users can work on the assumption that the appropriate requirements of the Ordinance are met and that they are thus acting in conformity with the law.

### Ladders as workplaces

- ▶ The commercial user may use ladders as workplaces when standing with both feet on a step (min. 80 mm depth) or platform.
- ▶ The use of step ladders or platform ladders as high-level workplaces is permitted without restriction up to a platform height of 2 metres.
- ▶ For a platform height between 2 metres and 5 metres, ladders may be used for work in limited periods (up to 2 hours per work shift).
- ▶ Layher offers in its simple ladder and double ladder range various ladder models with steps and /or platform.
- ▶ Layher also offers a suspended platform (Ref. No. 1016.003) as a retrofit set, which can be used to upgrade existing rung ladders from Layher and allow them to remain in use as workplaces.

### Use of rung ladders as workplaces in exceptional cases:

- ▶ In specifically justified exceptional cases (e.g. for work in narrow shafts, ergonomic reasons), working on portable ladders with rungs is permissible.
- ▶ The specific reasons must be documented by the contractor / commercial user in the risk assessment to be conducted for every activity / every site.

### Ladders as accesses

- ▶ Up to a height of 5 metres, rung ladders and step ladders may remain in use as accesses (entry / exit) to high-level workplaces.
- ▶ Above 5 metres, ladders may only be used as accesses when this is only a very infrequent occurrence.
- ▶ Layher recommends, for alternative access to high-level workplaces above 5 metres, scaffolding stair towers made using Layher Allround Scaffolding.

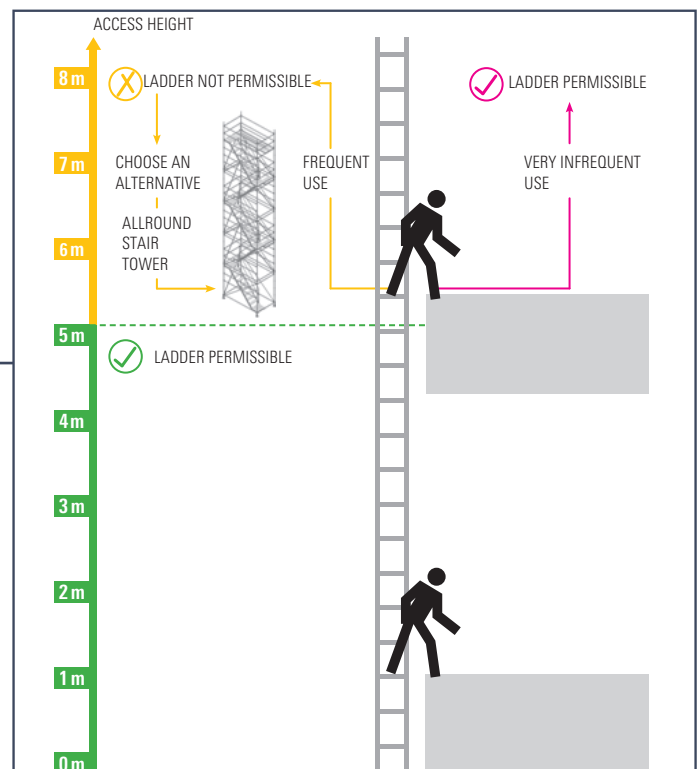
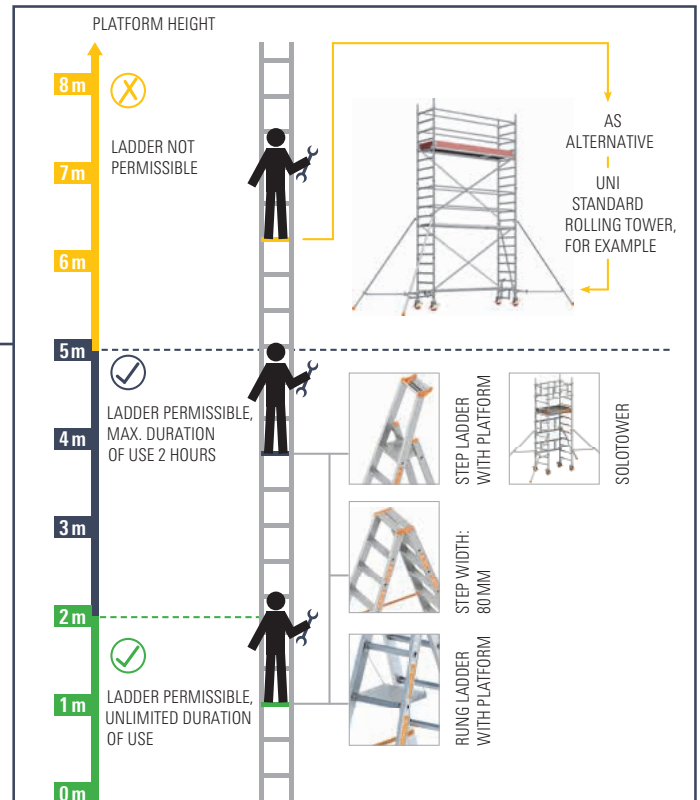

# LAYHER LADDERS

THE QUALITY IS IN THE DETAILS



### Plastic-sheathed steel joints

- ▶ Play-free screw connection for long life.



### Stile section

- ▶ Torsion stiff stile section for high loads at low weight.
- ▶ Beading along the outer stile face prevents damage to the rung flanges, for example when they are slid over the edges of the truck loading area.



### Quadruple folding

- ▶ Increased contact area by rung folding on the inner stile face.
- ▶ Higher forces can be transmitted.
- ▶ Optimal stile-rung-connection.

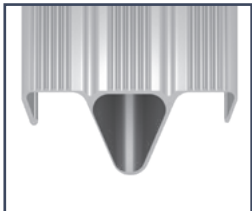

### Triangular profile and grooving

- ▶ Sure footing by heavily grooved rungs and steps. R12 slip resistance in step direction.
- ▶ Increased turning protection within the stiles thanks to triangular rung shape.



### Combigrip ladder foot

- ▶ Optimal hold in the stile with good slipping prevention.
- ▶ Easy and fast retrofitting of ladder cross-pieces for single ladders.



The load-bearing capacity of Layher Ladders is always 150 kg – if nothing different is mentioned.

With Layher ladders you don't just get the statutory warranty, but benefit from a 5-year Layher warranty. It covers material and workmanship flaws in all aluminium and steel parts. It starts from the purchase date of the product, as printed on your receipt.

The claims arising from this warranty will be processed at the location of one of our many branches or delivery warehouses in Germany or at our headquarters.

**Documented safety:** Layher products can be measured by these quality and safety standards:





## Single ladder wide *TOPIC* 1054

The wide single ladder for even more comfortable standing – increased stability and improved lateral stability. Slip-resistant plastic shoes for sure footing.

Clear width: **390 mm**  
 Outer width to 16 rungs: **448 mm**  
 Outer width from 18 rungs: **450 mm**  
 Rung spacing: **280 mm**  
 Cross-piece width (from 12 rungs): **1130 mm**

**TIP:**  
 With the Layher Combigrip ladder foot, you automatically comply with the new requirements of DIN EN 131-1, which will specify a cross-piece for simple ladders of 3 metres and more length. The Layher Combigrip ladder foot can be quickly and easily retrofitted in *TOPIC* ladders of earlier generations.  
 Retrofit kits see page 28.



Single ladder wide *TOPIC* 1054

Length [m]	Number of rungs	Standing height [m]	Stile height [mm]	Weight approx. [kg]	Ref. No.	
1.75	6	0.70	64	4.0	<b>1054.006</b>	
2.30	8	1.25	64	5.0	<b>1054.008</b>	
2.85	10	1.80	64	6.0	<b>1054.010</b>	
3.50	12	2.40	64	9.5	<b>1054.012</b>	ⓘ
4.05	14	2.90	64	11.0	<b>1054.014</b>	ⓘ
4.65	16	3.45	64	12.5	<b>1054.016</b>	ⓘ
5.20	18	3.95	76	13.5	<b>1054.018</b>	ⓘ
5.75	20	4.50	76	15.5	<b>1054.020</b>	ⓘ
6.30	22	5.00	76	16.5	<b>1054.022</b>	ⓘ
6.85	24	5.55	100	18.0	<b>1054.024</b>	ⓘ

**i** Ladders, highlighted with ⓘ will be delivered ex works with cross-piece.

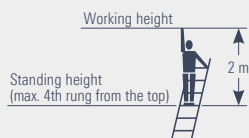

Suitable accessories



Other accessories can be found on page 26.

## Single step ladder *TOPIC* 1042

Single ladder with steps for a wider standing area. Easy to use, maximum safety thanks to slip-resistant plastic shoes.



Clear width: **390 mm**  
 Outer width: **450 mm**  
 Step spacing: **250 mm**  
 Step length: **80 mm**  
 Stile height: **76 mm**  
 Cross-piece width (from 12 rungs): **1130 mm**

**TIP:**  
 With the Layher Combigrip ladder foot, you automatically comply with the new requirements of DIN EN 131-1, which will specify a cross-piece for simple ladders of 3 metres and more length. The Layher Combigrip ladder foot can be quickly and easily retrofitted in *TOPIC* ladders of earlier generations.  
 Retrofit kits see page 28.



Single step ladder *TOPIC* 1042

Length [m]	Number of rungs	Standing height [m]	Max. load [kg]	Weight approx. [kg]	Ref. No.	
1.65	6	0.65	<b>250</b>	5.0	<b>1042.006</b>	📦
1.90	7	0.90	<b>250</b>	5.6	<b>1042.007</b>	📦
2.15	8	1.10	<b>250</b>	6.2	<b>1042.008</b>	📦
2.40	9	1.35	<b>250</b>	7.0	<b>1042.009</b>	📦
2.65	10	1.60	<b>250</b>	7.6	<b>1042.010</b>	📦
2.99	12	2.15	<b>250</b>	12.4	<b>1042.012</b>	📦 ⓘ
3.24	13	2.40	<b>250</b>	12.9	<b>1042.013</b>	📦 ⓘ
3.49	14	2.60	<b>250</b>	13.4	<b>1042.014</b>	📦 ⓘ
3.74	15	2.85	<b>250</b>	13.9	<b>1042.015</b>	📦 ⓘ
3.99	16	3.10	<b>225</b>	14.3	<b>1042.016</b>	📦 ⓘ
4.24	17	3.35	<b>225</b>	14.8	<b>1042.017</b>	📦 ⓘ
4.49	18	3.60	<b>225</b>	15.3	<b>1042.018</b>	📦 ⓘ

**i** Ladders, highlighted with ⓘ will be delivered ex works with cross-piece.

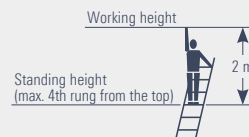

Suitable accessories

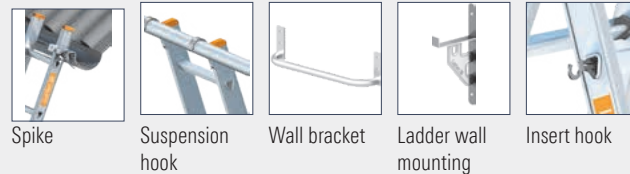

Other accessories can be found on page 26.

## Single ladders

### Wooden single ladder 1023 with rungs

The wooden single ladder has 80 mm wide and grooved steps for high slip resistance. Stiles are made of sturdy pine wood and the steps are made of solid beech. For more safety, the steps are inserted through a grooved joint in the stile, glued and screwed. The 1023.012 is delivered with a crossbar.

Clear width: **365 mm**  
 Outer width: **409 mm**  
 Step spacing: **250 mm**  
 Stile height: **70 mm**



### Wooden single ladder 1052

The wooden single ladder is a simple, sturdy yet high-quality ladder. The stiles are made of solid red pine. The rungs are made from sturdy beechwood. Thanks to the special square-section studs and a special gluing process, a durable and permanent connection between stile and rung is achieved.

Clear width: **350 mm**  
 Outer width: **400 mm**  
 Rung spacing: **280 mm**  
 Stile height: **65 mm**

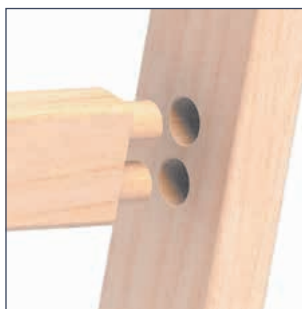

#### Wooden single ladder 1023

Length [m]	Number of rungs	Standing height [m]	Weight approx. [kg]	Ref. No.
1.80	6	0.71	5.5	<b>1023.006</b>
2.30	8	1.18	7.0	<b>1023.008</b>
2.80	10	1.65	9.0	<b>1023.010</b>
3.39	12	2.15	11.5	<b>1023.012</b> ⓘ

#### Wooden single ladder 1052

Length [m]	Number of rungs	Standing height [m]	Stile height [mm]	Weight approx. [kg]	Ref. No.
1.90	6	0.80	65	5.5	<b>1052.206</b> ⓘ
2.45	8	1.35	65	7.5	<b>1052.208</b> ⓘ
2.99	10	1.85	65	9.5	<b>1052.210</b> ⓘ

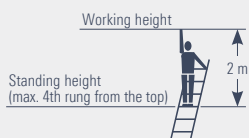

#### Suitable accessories

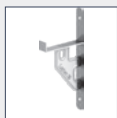

Ladder wall mounting

Other accessories can be found on page 26.

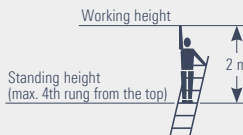

#### Suitable accessories



Suspended platform



Wood stile extension set EasyFix



Ladder shoe for wooden ladder



Ladder wall mounting

Other accessories can be found on page 26.

## Wooden single ladder for builders 1036

The classic wooden single ladder is ideal for many applications, e.g. rugged use on construction sites. Stiles and rungs made of narrow-ringed spruce. Due to its conical design with pointed bar ends, the builder's ladder 1036 corresponds to the DIN 4567-3 and is therefore not subject to cross-piece obligation according to DIN EN 131.

Stile width: **40 mm**  
 Outer width at top: **385 mm**  
 Rung spacing: **280 mm**



### Wooden single ladder for builders 1036

Length [m]	Number of rungs	Standing height [m]	Stile height [mm]	Outer width at bottom [mm]	Weight approx. [kg]	Ref. No.
3.00	10	1.85	85	430	11.9	<b>1036.010</b>
4.00	14	2.90	90	450	16.6	<b>1036.014</b>
5.00	17	3.70	95	470	20.2	<b>1036.017</b>
6.00	21	4.75	100	490	25.0	<b>1036.021</b>

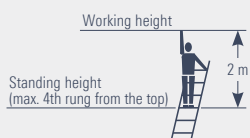

#### Suitable accessories



Ladder wall mounting

Other accessories can be found on page 26.

## Combination single ladder 1029

The classic single ladder has remarkable weight advantages thanks to the aluminium rungs which are suitable for regular and continuous use. Ideal for electricians and craftsmen as the ladder is electrically non-conductive. Information on the insulation resistance, in accordance with VDE 0100, is available. From a length of 3 m the ladder 1029 does not correspond to the newest version of the DIN EN 131.

Available while stocks last.

Clear width: **300 mm**  
 Outer width: **350 mm**  
 Rung spacing: **280 mm**  
 Stile height: **75 mm**



### Combination single ladder 1029

Length [m]	Number of rungs	Standing height [m]	Stile height [mm]	Weight approx. [kg]	Ref. No.
2.40	8	1.30	75	5.8	<b>1029.008</b>
2.95	10	1.85	75	6.8	<b>1029.010</b>
3.50	12	2.40	75	8.6	<b>1029.012</b>
4.05	14	2.90	75	9.6	<b>1029.014</b>
4.35	15	3.15	75	10.2	<b>1029.015</b>
4.90	17	3.70	75	11.8	<b>1029.017</b>

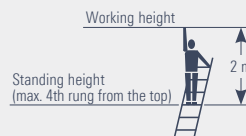

#### Suitable accessories

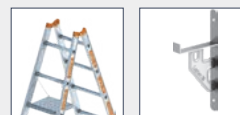

Suspended platform

Ladder wall mounting

Other accessories can be found on page 26.

## Extension step ladder *TOPIC 1032*



The Extension Step Ladder *TOPIC 1032* has the proven torsionstiff stile sections for high loads with a low weight. It also has, in accordance with DIN EN 131-1, a 1130 mm wide cross-piece to widen the base.

The extending ladder (top section) is behind the bottom section, enabling smooth ascents and descents while reducing the risk of stumbling.

- Clear width: **390 mm**
- Outer width: **450 mm**
- Rung spacing: **250 mm**
- Cross-piece width: **1130 mm**
- Stile height: **76 mm**

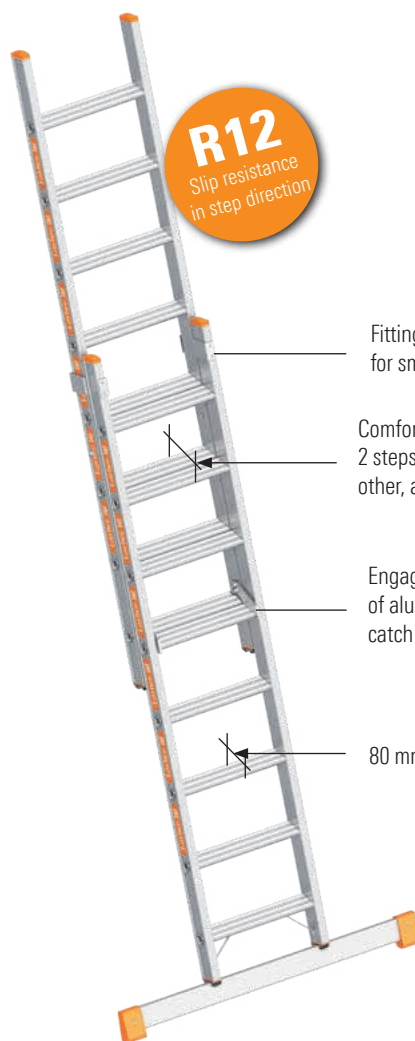

**R12**  
Slip resistance  
in step direction

Fittings made of aluminium for smooth movement

Comfortable stance with 2 steps one behind the other, almost like on a platform

Engaging hooks made of aluminium and safety catch of plastic

80 mm deep steps



Extension step ladder *TOPIC 1032*

Length contr. [m]	Length extend. [m]	Number of rungs	Standing height [m]	Weight approx. [kg]	Ref. No.
2.29	3.30	2 x 8	2.10	15.0	<b>1032.008</b>
2.79	4.30	2 x 10	3.10	17.8	<b>1032.010</b>
3.29	5.30	2 x 12	4.00	20.5	<b>1032.012</b>
3.79	6.30	2 x 14	4.95	23.3	<b>1032.014</b>

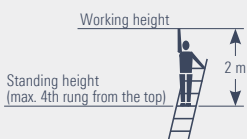

### Suitable accessories



Top rollers



Suspension hook



Cross-piece castors



Wall bracket

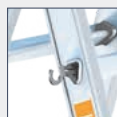

Insert hook

Other accessories can be found on page 26.

### THE BENEFITS FOR YOU

- ▶ Steps made of aluminium, grooved for better anti-slip resistance.
- ▶ 80 mm deep steps, conforming to TRBS 2121-2 guidelines.
- ▶ Comfortable stance with two steps one behind the other (like a platform).
- ▶ Comfortable width of 390 mm.
- ▶ Sturdy aluminium fittings and engaging hooks.
- ▶ Step spacing of 250 mm.
- ▶ Maximum load of 150 kg.
- ▶ Cross-piece for all four ladder sizes.

## Extension ladder *TOPIC* 1035



Two-part extension ladder for greater heights, with short transport and storage dimensions. Manual length adjustment rung by rung using engaging hook, secured against lifting out and sliding out of position on transport and use. The *TOPIC* 1035 can optionally be equipped with top rollers.

Clear width top section: **300 mm**  
 Clear width bottom section: **377 mm**  
 Outer width: **438 mm**  
 Rung spacing: **280 mm**  
 Cross-piece width (to 10 rungs): **890 mm**  
 Cross-piece width (to 12 rungs): **1360 mm**



**TIP:**  
 With the Layher Combigrip ladder foot, you automatically comply with the new requirements of DIN EN 131-1, which will specify a cross-piece for simple ladders of 3 metres and more length. The Layher Combigrip ladder foot can be quickly and easily retrofitted in *TOPIC* ladders of earlier generations. Retrofit kits see page 28.

Extension ladder *TOPIC* 1035

Length contr. [m]	Length extend. [m]	Number of rungs	Standing height [m]	Stile height [mm]	Weight approx. [kg]	Ref. No.	
1.75	2.85	2 x 6	1.80	64	7.6	<b>1035.006</b>	
2.39	3.80	2 x 8	2.65	64	12.5	<b>1035.008</b>	ⓘ
2.94	4.80	2 x 10	3.70	76	14.6	<b>1035.010</b>	ⓘ
3.49	5.95	2 x 12	4.75	76	18.4	<b>1035.012</b>	ⓘ
4.09	7.05	2 x 14	5.85	100	22.2	<b>1035.014</b>	ⓘ
4.64	8.00	2 x 16	6.60	100	24.6	<b>1035.016</b>	ⓘ
5.19	9.10	2 x 18	7.65	100	28.8	<b>1035.018</b>	ⓘ

ⓘ Ladders, highlighted with ⓘ will be delivered ex works with cross-piece.

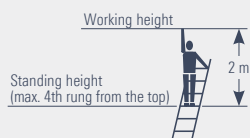

Suitable accessories



Other accessories can be found on page 26.

## Rope extension ladder *TOPIC* 1037



For great heights. Always achieve the right working height thanks to rung-by-rung extension. Easy to use rope control, long-life plastic rope, releasing, lowering and securing with automatic drop catch. Rollers with rubber tyre to prevent damage when running up and down walls.

Clear width top section: **300 mm**  
 Clear width bottom section: **375 mm**  
 Outer width: **438 mm**  
 Rung spacing: **280 mm**  
 Cross-piece width: **1360 mm**  
 Stile height: (reinforced): **100 mm**

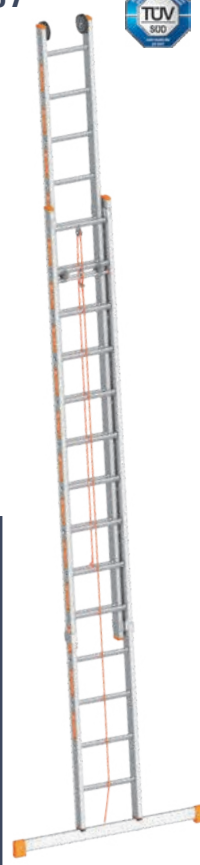

**TIP:**  
 With the Layher Combigrip ladder foot, you automatically comply with the new requirements of DIN EN 131-1, which will specify a cross-piece for simple ladders of 3 metres and more length. The Layher Combigrip ladder foot can be quickly and easily retrofitted in *TOPIC* ladders of earlier generations. Retrofit kits see page 28.

Rope extension ladder *TOPIC* 1037

Length contr. [m]	Length extend. [m]	Number of rungs	Standing height [m]	Weight approx. [kg]	Ref. No.	
4.09	7.15	2 x 14	5.80	23.6	<b>1037.014</b>	ⓘ
4.64	8.30	2 x 16	6.85	26.2	<b>1037.016</b>	ⓘ
5.19	9.10	2 x 18	7.60	31.0	<b>1037.018</b>	ⓘ
5.74	10.25	2 x 20	8.70	34.4	<b>1037.020</b>	ⓘ
6.29	11.35	2 x 22	9.75	37.6	<b>1037.022</b>	ⓘ

ⓘ Ladders, highlighted with ⓘ will be delivered ex works with cross-piece.

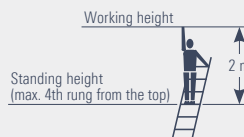

Suitable accessories



Other accessories can be found on page 26.

### Wooden double ladder with steps 1020

The classic craftsman's ladder. With 80 mm wide steps, access from either side and complete with tool bag, over-spreading prevented by 2 polyester straps, adjustable clamping pins, sturdily designed and galvanized steel hinges with bucket hook, metal catch at bottom of ladder to secure it during transport. Stiles of solid red pine. Rungs made of sturdy beechwood. Thanks to the special square-section studs and a special gluing process, a durable and permanent connection between stile and rung is achieved.

Step length: **80 mm**  
 Step spacing: **250 mm**  
 Stile height: **70 mm**



Wooden double ladder with steps 1020

Length [m]	Number of steps	Standing height [m]	Outer width at bottom [mm]	Weight approx. [kg]	Ref. No.
1.15	2 x 4	0.47	0.50	7.7	<b>1020.004</b>
1.40	2 x 5	0.70	0.53	9.6	<b>1020.005</b>
1.65	2 x 6	0.94	0.56	11.6	<b>1020.006</b>
1.90	2 x 7	1.18	0.58	13.6	<b>1020.007</b>
2.15	2 x 8	1.41	0.61	15.7	<b>1020.008</b>
2.40	2 x 9	1.64	0.64	17.8	<b>1020.009</b>
2.65	2 x 10	1.88	0.66	20.0	<b>1020.010</b>

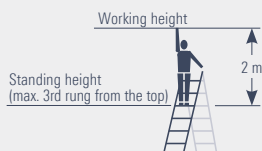

Suitable accessories



Ladder shoe for wooden ladder

Other accessories can be found on page 26.

### Wooden double ladder 1038

The classic craftsman's ladder. Access from either side and complete with tool bag, over-spreading prevented by 2 polyester straps, adjustable clamping pins, sturdily designed and galvanized steel hinges with bucket hook, metal catch at bottom of ladder to secure it during transport. Stiles of solid red pine. Rungs made of sturdy beechwood. Thanks to the special square-section studs and a special gluing process, a durable and permanent connection between stile and rung is achieved.

Rung length: **22 mm**  
 Rung spacing: **280 mm**

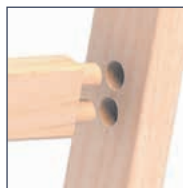

Wooden double ladder 1038

Length [m]	Number of rungs	Standing height [m]	Outer width at bottom [mm]	Stile height [mm]	Weight approx. [kg]	Ref. No.
0.95	2 x 3	0.30	0.47	65	5.7	<b>1038.203</b>
1.25	2 x 4	0.55	0.50	65	7.4	<b>1038.204</b>
1.55	2 x 5	0.80	0.53	65	8.9	<b>1038.205</b>
1.80	2 x 6	1.05	0.56	65	10.4	<b>1038.206</b>
2.10	2 x 7	1.30	0.59	65	12.5	<b>1038.207</b>
2.35	2 x 8	1.60	0.62	65	14.3	<b>1038.208</b>
2.65	2 x 9	1.85	0.65	65	15.7	<b>1038.209</b>
2.95	2 x 10	2.10	0.68	65	17.5	<b>1038.210</b>
3.50	2 x 12	2.65	0.74	70	25.5	<b>1038.212</b>
4.05	2 x 14	3.15	0.80	70	30.0	<b>1038.214</b>

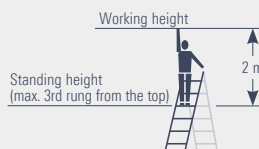

Suitable accessories



Suspended platform



Wood stile extension set EasyFix



Ladder shoe for wooden ladder

Other accessories can be found on page 26.

## Wooden double ladder acc. to Ö-Norm Z1501 1053

The both side accessible wooden ladder for special professional use. It contains ergonomic needs of painters, wallpaperers while long standing on the rungs. The ladders according to the additional Austrian standard Z1501 are made accordingly to EN 131-1 and -2, excepting the two top rung spacings. They are 320 mm for comfortable standing on the ladder.

The configuration is the same as the wooden double ladder 1038

Rung spacing:  
**280 mm und 320 mm**

AUVA approved

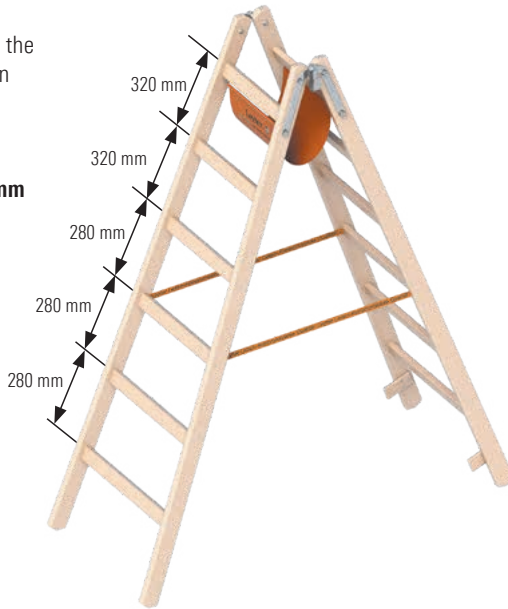

### Wooden double ladder 1053 acc. to Ö-Norm

Length [m]	Number of rungs	Standing height [m]	Outer width at bottom [mm]	Stile height [mm]	Weight approx. [kg]	Ref. No.
1.30	2 x 4	0.55	0.53	65	7.4	<b>1053.204</b>
1.60	2 x 5	0.80	0.56	65	9.2	<b>1053.205</b>
1.90	2 x 6	1.05	0.58	65	10.7	<b>1053.206</b>
2.15	2 x 7	1.30	0.61	65	12.8	<b>1053.207</b>
2.45	2 x 8	1.60	0.64	65	14.6	<b>1053.208</b>
2.70	2 x 9	1.85	0.67	65	16.0	<b>1053.209</b>
3.00	2 x 10	2.10	0.70	65	17.8	<b>1053.210</b>
3.56	2 x 12	2.65	0.76	70	25.8	<b>1053.212</b>

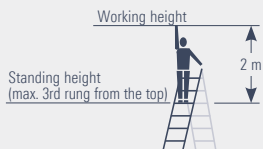

#### Suitable accessories



Ladder shoe for wooden ladder

Other accessories can be found on page 26.

## Combination double ladder 1028

The wood / aluminium ladder, tried, tested and praised by craftsmen. Ideal for electricians and craftsmen, as it is not electrically conductive. Information on the insulation resistance, in accordance with **VDE 0100** is available. Sturdy and torsion-stiff design. Extra-strong steel hinges, tear-proof polyester straps to prevent over-spreading.

Rung spacing: **280 mm**  
Stile height: **75 mm**

Available while stocks last.



### Combination double ladder 1028

Length [m]	Number of rungs	Standing height [m]	Outer width at bottom [mm]	Weight approx. [kg]	Ref. No.
1.55	2 x 5	0.80	0.50	7.6	<b>1028.005</b>
1.80	2 x 6	1.05	0.53	9.0	<b>1028.006</b>
2.10	2 x 7	1.30	0.56	11.0	<b>1028.007</b>
2.35	2 x 8	1.60	0.59	12.6	<b>1028.008</b>
2.95	2 x 10	2.10	0.65	16.0	<b>1028.010</b>
3.50	2 x 12	2.65	0.71	19.2	<b>1028.012</b> 

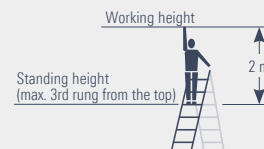

#### Suitable accessories



Suspended platform    Suspended bag with hook    TOPIC Box    Insert hook

Other accessories can be found on page 26.

## Double ladders

### Double step ladder *TOPIC 1043*



The classic double ladder design with comfortable and wide steps. Plastic-sheathed steel hinges, angle reinforcements and tear-proof polyester straps are quality features. The two top steps make up a platform. The *TOPIC 1043* is also available with chain as protection against over-spreading.

Step spacing: **250 mm**  
Step length: **80 mm**  
Stile height: **76 mm**



Double step ladder *TOPIC 1043*

Length [m]	Number of steps	Standing height [m]	Outer width at bottom [mm]	Max. load [kg]	Weight approx. [kg]	Ref. No.
0.75	2 x 3	0.25	0.46	250	5.6	<b>1043.003</b>
1.00	2 x 4	0.50	0.48	250	6.8	<b>1043.004</b>
1.25	2 x 5	0.70	0.51	250	8.4	<b>1043.005</b>
1.50	2 x 6	0.95	0.53	200	9.8	<b>1043.006</b>
1.75	2 x 7	1.20	0.57	200	11.4	<b>1043.007</b>
2.00	2 x 8	1.40	0.60	200	13.4	<b>1043.008</b>
2.50	2 x 10	1.90	0.66	150	16.2	<b>1043.010</b>
3.00	2 x 12	2.40	0.72	150	19.8	<b>1043.012</b>

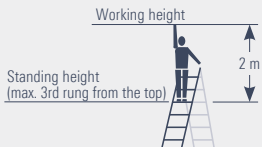

#### Suitable accessories



TOPIC Box



Insert hook



Spike

Other accessories can be found on page 26.

### Double step ladder *TOPIC 1043.1*

An extension of the classic step ladder with comfortable and wide steps, **plastic-sheathed steel hinges**, angle reinforcements and tear-proof polyester straps are quality features. Parallel stiles with a stile height of 76 mm, a clear width of 390 mm and cross-pieces on both sides guarantee a high level of safety plus convenient access.

Step spacing: **250 mm**  
Step length: **80 mm**  
Stile height: **76 mm**  
Cross-piece width: **1130 mm**  
Outer width: **450 mm**  
Maximum load: **150 kg**

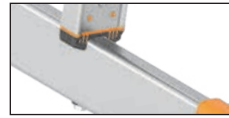

Double step ladder *TOPIC 1043.1*

Length [m]	Number of steps	Standing height [m]	Weight approx. [kg]	Ref. No.
3.39	2 x 13	2.60	25.6	<b>1043.113</b>
3.64	2 x 14	2.85	26.6	<b>1043.114</b>
3.89	2 x 15	3.05	27.6	<b>1043.115</b>
4.14	2 x 16	3.30	28.6	<b>1043.116</b>

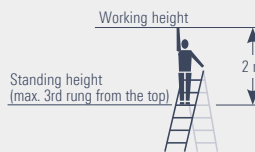

#### Suitable accessories



TOPIC Box



Cross-piece castors



Insert hook

Other accessories can be found on page 26.



## Double step ladder with access on one side *TOPIC 1064*



A safer stance at all times from the platform, extended stiles and knee bar shaped as a storage tray. The amply dimensioned platform folds up for transport. Tear-proof polyester straps to prevent over-spreading. The *TOPIC 1064* is also available with chain as protection against over-spreading.

Step spacing: **250 mm**  
 Step length: **80 mm**  
 Platform dimensions: **248 x 300 mm**  
 Stile height: **76 mm**



Double step ladder with access on one side *TOPIC 1064*

Length [m]	Number of steps	Standing height [m]	Outer width at bottom [mm]	Weight approx. [kg]	Ref. No.
1.45	3	0.70	0.46	6.2	<b>1064.003</b>
1.70	4	0.95	0.48	7.0	<b>1064.004</b>
1.95	5	1.20	0.51	8.0	<b>1064.005</b>
2.20	6	1.40	0.53	9.2	<b>1064.006</b>
2.45	7	1.65	0.57	10.4	<b>1064.007</b>
2.70	8	1.90	0.60	11.6	<b>1064.008</b>
2.95	9	2.10	0.64	13.2	<b>1064.009</b>
3.20	10	2.35	0.66	14.0	<b>1064.010</b>
3.70	12	2.80	0.72	16.4	<b>1064.012</b>

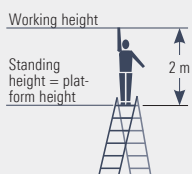

### Suitable accessories

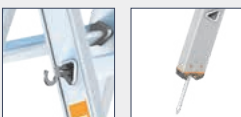

Insert hook Spike

Other accessories can be found on page 26.

## Platform ladder *TOPIC 1074*



The *TOPIC 1074* platform ladder for access from one side is a comfortable aid to doing lengthy work on the ladder. The large 480 x 420 mm platform using a non-slip grooved metal plate ensures a sure footing particularly for lengthy work on the ladder. Handrails fitted to the stile on both sides permit a safer grip when climbing up and down the ladder.

Step spacing: **250 mm**  
 Step length: **80 mm**  
 Platform dimensions: **480 x 420 mm**  
 Stile height: **76 mm**  
 Cross-piece width: **890 mm**



Platform ladder *TOPIC 1074*

Length [m]	Number of steps	Standing height [m]	Projection [m]	Weight approx. [kg]	Ref. No.
2.09	4	0.90	0.99	12.0	<b>1074.004</b>
2.34	5	1.20	1.14	13.2	<b>1074.005</b>
2.59	6	1.40	1.27	14.7	<b>1074.006</b>
2.84	7	1.60	1.41	15.6	<b>1074.007</b>
3.09	8	1.90	1.55	16.3	<b>1074.008</b>

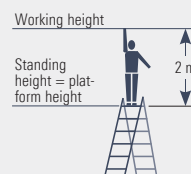

### Suitable accessories

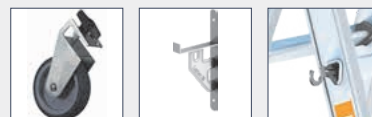

Cross-piece castors Ladder wall mounting Insert hook

Other accessories can be found on page 26.

## Double ladders

### Stair Double Ladder With Steps *TOPIC 1062*

The professional solution not just for stairways. With the stairway double ladder, level equalization on uneven surfaces or stairways is no problem. The sturdy design and well thought-out details ensure optimum handling.

The stile extensions permanently attached to the ladder are quick to lock and easy to use thanks to rotary knobs fitted on the inside of the stile.

Step spacing: **250 mm**  
Step length: **80 mm**  
Maximum load: **150 kg**



#### Stair Double Ladder With Steps *TOPIC 1062*

Length [m]	Number of rungs	Standing height [m]	Outer width of ladder stiles at bottom [m]	Weight approx. [kg]	Ref. No.
1.25	2 x 5	0.70	0.58	14.3	<b>1062.005</b>
1.50	2 x 6	0.95	0.61	15.3	<b>1062.006</b>
1.75	2 x 7	1.20	0.65	17.3	<b>1062.007</b>
2.00	2 x 8	1.40	0.68	19.3	<b>1062.008</b>

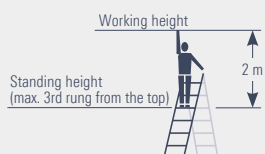

#### Suitable accessories



Spike

TOPIC Box

Other accessories can be found on page 26.

### Stair Double Ladder *TOPIC 1061*



The stile extensions permanently attached to the ladder are quick to lock and easy to use thanks to rotary knobs fitted on the inside of the stile. The stile extensions have an adjustment range of 40 cm on one side and of 102 cm on the other side.

Rung spacing: **280 mm**  
Stile height: **64 mm**



#### Stair Double Ladder *TOPIC 1061*

Length [m]	Number of rungs	Standing height [m]	Projection [m]	Weight approx. [kg]	Ref. No.
1.55	2 x 5	0.80	1.20	13.3	<b>1061.005</b>
1.85	2 x 6	1.05	1.40	14.6	<b>1061.006</b>
2.10	2 x 7	1.30	1.60	15.7	<b>1061.007</b>
2.40	2 x 8	1.60	1.75	17.1	<b>1061.008</b>

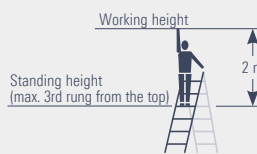

#### Suitable accessories



Suspended platform

Suspended bag with hook

TOPIC Box

Insert hook

Spike

Other accessories can be found on page 26.

## Double rung ladder *TOPIC 1039*



The traditional double ladder with a wide range of safety features: Plastic-sheathed steel hinges, tear-proof polyester straps to prevent over-spreading, slip-resistant plastic shoes. Additional stiffeners at the end of the stile ensure that the values specified in DIN EN 131 are bettered. The *TOPIC 1039* is also available with chain as protection against over-spreading.

Rung spacing: **280 mm**  
 Stile height (to 14 rungs): **64 mm**  
 Stile height (to 16 rungs): **76 mm**



### Double rung ladder *TOPIC 1039*

Length [m]	Number of rungs	Standing height [m]	Projection [m]	Stile height [mm]	Weight approx. [kg]	Ref. No.
1.30	2 x 4	0.55	1.00	64	6.0	<b>1039.004</b>
1.55	2 x 5	0.80	1.20	64	6.8	<b>1039.005</b>
1.85	2 x 6	1.05	1.40	64	8.0	<b>1039.006</b>
2.10	2 x 7	1.30	1.60	64	9.2	<b>1039.007</b>
2.40	2 x 8	1.60	1.75	64	10.4	<b>1039.008</b>
2.70	2 x 9	1.85	1.95	64	12.0	<b>1039.009</b>
2.95	2 x 10	2.10	2.15	64	13.2	<b>1039.010</b>
3.50	2 x 12	2.65	2.55	64	16.0	<b>1039.012</b>
4.10	2 x 14	3.15	2.90	64	18.8	<b>1039.014</b>
4.65	2 x 16	3.70	3.30	76	24.9	<b>1039.016</b> ⊕
5.20	2 x 18	4.20	3.70	76	30.1	<b>1039.018</b> ⊕

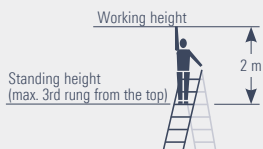

#### Suitable accessories



Suspended platform

Suspended bag with hook

Insert hook

Spike

Other accessories can be found on page 26.

## Folding ladder *TOPIC 1056*

The Layher folding Ladder *TOPIC 1056* is the perfect choice if you're using a double ladder that can be turned quickly and easily into a simple ladder. Strong and securely engaging steel joints ensure the required working position. For optimum stability, the Layher folding Ladder is fitted on one side with an 890 mm wide cross-piece. All-round grooved triangular rungs, quadruple-folded with the stile, ensure comfortable and sure footing at all times.



Stile height: **64 mm**  
 Outer width: **393 mm**  
 Rung spacing: **280 mm**  
 Cross-piece width: **890 mm**

#### Assembly variants



### Folding ladder *TOPIC 1056*

Max. length [m]	Min. length [m]	Number of rungs	Standing height double ladders [m]	Standing height single ladders [m]	Weight approx. [kg]	Ref. No.
2.45	1.34	4	0.55	1.30	7.8	<b>1056.008</b> 📦
3.60	1.94	6	1.10	2.35	9.5	<b>1056.012</b> 📦
4.70	2.49	8	1.60	3.40	11.6	<b>1056.016</b> 📦

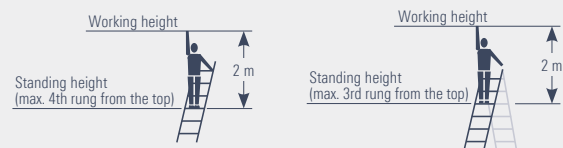

#### Suitable accessories



Suspended platform

Insert hook

Other accessories can be found on page 26.



## Telescopic ladder *TOPIC 1058*

Very versatile in use: as double ladder with variable height adjustment on one side. As a classic single ladder. And as two separate work trestles. Manual length adjustment rung by rung. Sturdy pin joints secure the ladder in the appropriate setting for use. The standing width of the *TOPIC 1058* with base widening corresponds to the latest version of the DIN EN 131-4.

Rung spacing: **280 mm**  
Stile height: **64 mm**



Corresponds to the DIN EN 131-4

Not included in delivery.

### Assembly variants

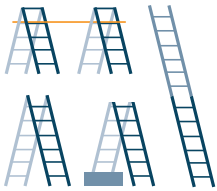

Telescopic ladder *TOPIC 1058*

Max. length [m]	Number of rungs	Standing height double ladder [m]	Standing height single ladder [m]	Weight approx. [kg]	Ref. No.
4.15	4 x 4	1.35	3.00	14.0	<b>1058.016</b>
5.25	4 x 5	1.90	4.10	16.7	<b>1058.020</b>
6.40	4 x 6	2.45	5.15	20.5	<b>1058.024</b>

### Transport/packaging dimensions:

**1058.016:** 1.33 x 0.60 x 0.22 m

**1058.020:** 1.55 x 0.67 x 0.22 m

**1058.024:** 1.85 x 0.72 x 0.22 m

### Stile extension

Usable as stile extension and as a cross-piece.

Max. permissible stile extension: 450 mm

Weight approx. [kg]	Ref. No.
1.6	<b>1058.001</b>



Base widening – see page 28

## Alu telescopic stage

The Alu telescopic stage offers a wide and variable range of possible applications. For transport, the telescopic stage can be simply pushed together, resulting in low transport dimensions. Since the Alu telescopic stage is extendable, it can be pulled out or pushed together to provide any required length. The automatic locking mechanism ensures that the inner extending element cannot slide out by mistake. The supporting structure is made of specially developed and torsion-stiff extruded aluminium sections. All section ends are provided with plastic caps. They act as sliding elements and provide protection from injury. Thanks to these plastic sliding elements, the effort required to slide the telescopic stage in and out is very low.

Height: **80 mm**  
Width: **305 mm**

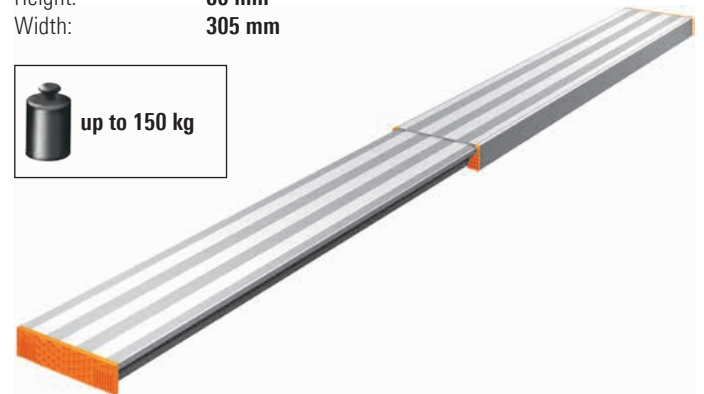

Alu telescopic stage

Max. length [m]	Min. length [m]	Weight approx [kg]	Ref. No.
2.9	1.64	13.0	<b>1351.290</b>
3.5	1.92	16.0	<b>1351.350</b>
4	2.27	18.0	<b>1351.400</b>
4.4	2.49	20.0	<b>1351.440</b>

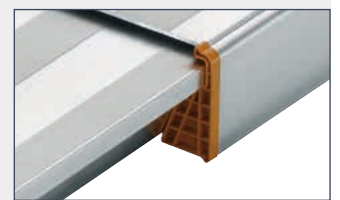

Working platform **TOPIC 1065**

**NEW**

The foldable work platform **TOPIC 1065** is the convenient tool for both indoor and outdoor work. The high-quality plywood plate has a non-slip surface and a practical recessed grip, making the working platform easy to transport with its low weight.

- Step spacing: **250 mm**
- Step length: **80 mm**
- Stile width ascent ladder: **76 mm**
- Stile width platform: **64 mm**
- Platform dimension: **1500 x 500 mm**
- Maximum load: **300 kg**

**R12**  
Slip resistance  
in step direction

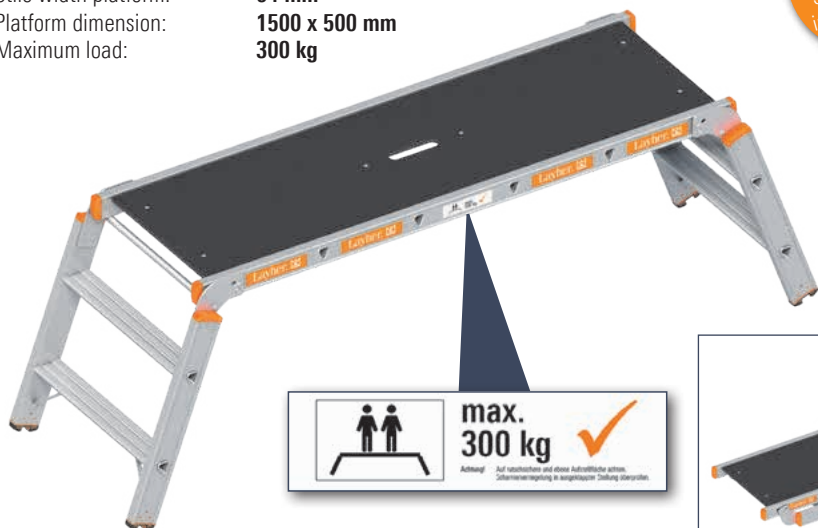

**max. 300 kg**  
Auf verschleiß- und abriebempfindliche Oberflächen  
Zuverlässigkeit & langjährige Nutzung garantiert.



Increased slip resistance due to 80 mm wide steps made of aluminum with slip resistance **R12** in the direction of steps.



Working platform **TOPIC 1065**

Length [m]	Number of steps	Standing height [m]	Outer width at bottom [m]	Maximum load [kg]	Weight approx. [kg]	Ref. No.
1.59	2 x 2	0.65	0.57	300	15.7	1065.065



**THE BENEFITS FOR YOU:**

- ▶ Lightweight and stable construction made of aluminum stiles in the familiar Layher design.
- ▶ Quick and easy assembly thanks to hinges with quick-release fasteners that automatically lock into place.
- ▶ 80 mm wide grooved steps with a slip resistance class R12, for a comfortable and safe ascent and descent.
- ▶ Safe working on a standing surface of 1500 x 500 mm.
- ▶ Anti-slip platform covering (R12 rating group).
- ▶ The working platform is approved for 2 persons and max. 300 kg.
- ▶ Non-slip 2-component shoes.
- ▶ Quickly foldable for transport and storage.

## Alu heavy-duty step TOPIC 1043.3

The classic step design with comfortable and wide steps. Plastic-sheathed steel hinges, angle reinforcements and tear-proof polyester straps are quality features. The platform at the top can be footed. The heavy-duty step conforms to European Standard DIN EN 14183 -B.

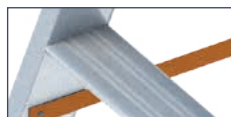

Step spacing: **250 mm**  
 Step length: **80 mm**  
 Stile height: **76 mm**  
 Platform dimensions: **480 x 285 mm**  
 Maximum load: **200 kg**

Alu heavy-duty step TOPIC 1043.3

Length [m]	Number of rungs	Standing height [m]	Outer width at bottom [mm]	Weight approx. [kg]	Ref. No.
0.90	2 x 3	0.70	0.64	8.4	1043.303
1.15	2 x 4	0.95	0.67	9.6	1043.304

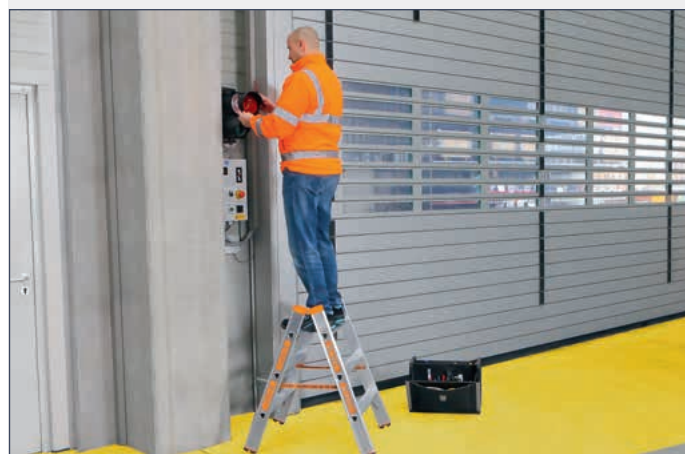
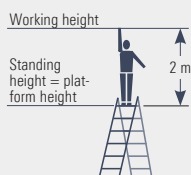

## Work trestle TOPIC 1047

Aluminium work trestle. Safe access on one side thanks to wide steps. Ideal as a lightweight, simple and small scaffolding for construction work. Folds together for transport. One side with round tubes for suspension of rolling tower deck sections (0.68 m wide) or 2 Alu telescopic stages as working platform.

Step spacing: **250 mm**  
 Step length: **80 mm**  
 Breite ausgeklappt: **950 mm**  
 Width when folded out: **750 mm**



Work trestle TOPIC 1047

Length [m]	Number of rungs	Standing height [m]	Stile height [mm]	Maximum load [kg]	Weight approx. [kg]	Ref. No.
1.15	4	0.98	76	150	9.6	1047.704



More information about the bridging deck, see page 118/119.

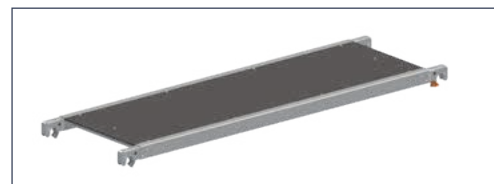

### Machine step 1075

The machine step made of aluminium is a safer and more convenient aid to assembly and maintenance work on machinery, and for access to high shelves in warehouse logistics. The sturdy welded tube design with a large platform to stand on (540 x 310 mm) ensures a safer footing in particular during work over lengthy periods. Wide steps (580 x 225 mm) ensure safer ascents and descents. The platform and the steps are made from a grooved aluminium plate to make them non-slip. The machine step 1075 conforms to European Standard DIN EN 14183-C.

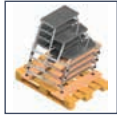
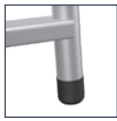

#### Machine step 1075

Length [m]	Number of rungs	Standing height [m]	Projection [m]	Weight approx. [kg]	Ref. No.
0.80	2	0.40	0.53	6.8	<b>1075.002</b>
0.75	3	0.60	0.73	10.0	<b>1075.003</b>
0.95	4	0.80	0.94	13.5	<b>1075.004</b>
1.15	5	0.99	1.14	17.2	<b>1075.005</b>

#### Castors for machine step

Thanks to the optional castors, the machine step 1075 can be moved horizontally from place to place both quickly and ergonomically. The castors can be fitted in a quick operation by the user to all length versions.

Weight approx. [kg]	PU	Ref. No.
0.5	2	<b>1016.751</b>



### Folding wooden step 1055

Steps with access on one side for fitting and servicing work. Ideal for plasterers, drywall installers and painters. Ample sized standing surface and wide steps for safer and comfortable working. For ease of transport, a practical grip hole has been cut out from the standing surface. Protection against over-spreading made of galvanized steel. Stiles made of narrow-ringed yellow pine. Grooved steps made of sturdy beechwood.

Step spacing: **250 mm**  
 Step length: **115 mm**  
 Platform dimension: **215 x 565 mm**  
 Outer width: **565 mm**

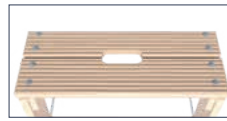

#### Folding wooden steps 1055

Length [m]	Number of rungs	Standing height [m]	Projection [m]	Weight approx. [kg]	Ref. No.
0.75	3	0.65	0.70	6.8	<b>1055.003</b>
1.00	4	0.85	0.85	8.5	<b>1055.004</b>

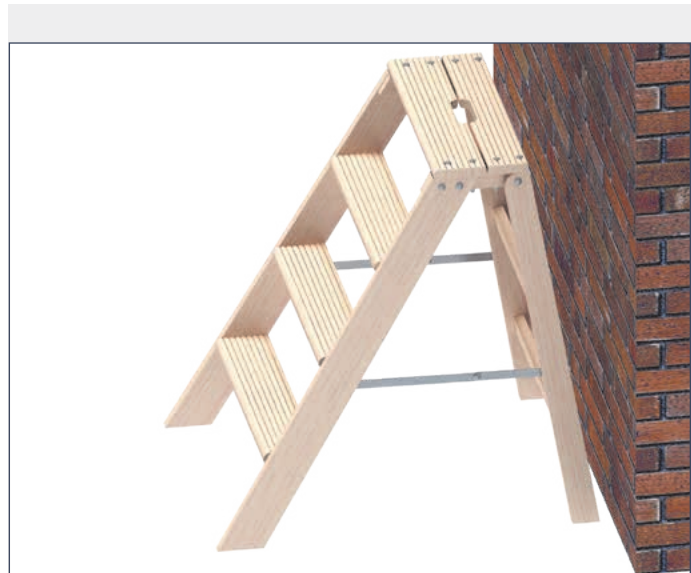



## Wallpaperer's trestle 1045

The sturdy structure for the professional user. Sturdy, galvanized steel hinges. Stiles made of pine wood and rungs made of solid beechwood.

The wallpaperer's trestle may not be used as a ladder and stepping on the rungs is not allowed.

Support strip: **650 mm**



### Wallpaperer's trestle 1045

Length [m]	Projection [m]	Support height [m]	Weight approx. [kg]	Ref. No.
0.85	0.75	0.80	4.4	<b>1045.202</b>
1.00	0.80	0.95	5.2	<b>1045.203</b>

## Truck ladder 1060

Ultra-light simple ladder made of aluminium. Ideal for accessing the truck loading surface. Optimum stability and functionality from soft rubber shoes around the stile ends. This means that the ladder is suitable not only for access to the loading surface, but also for leaning up against the cab to clean its windscreen without damaging the vehicle paintwork.

Clear width: **300 mm**  
 Outer width: **350 mm**  
 Rung spacing: **280 mm**



### Truck ladder 1060

Length [m]	Number of rungs	Standing height [m]	Stile height [mm]	Maximum load [kg]	Weight approx. [kg]	Ref. No.
2.10	7	1.05	50	150	3.3	<b>1060.007</b>

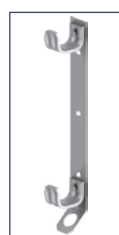

A matching holder is available for optimum attachment of truck ladder 1060 to the vehicle.  
**Ref. No. 1060.001**

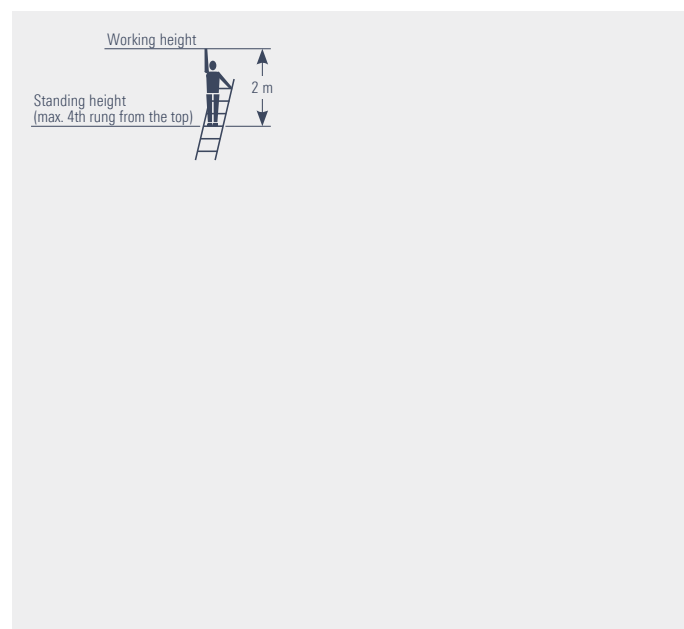

### Suitable accessories



Ladder shoe for wooden ladder

Other accessories can be found on page 26.

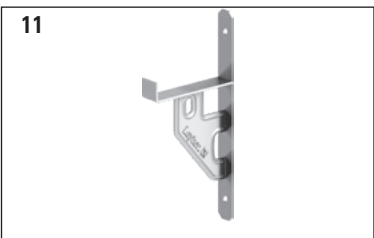
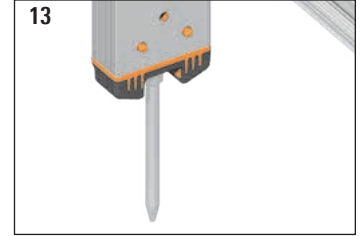
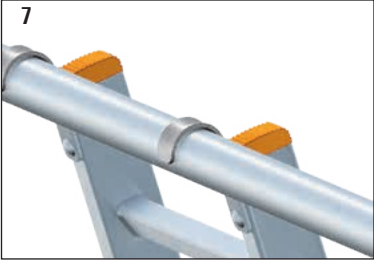
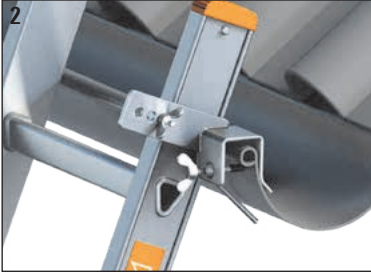
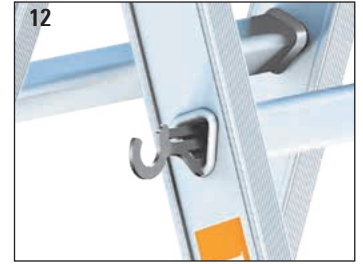

Pos.	Description	Dimensions [m]	Weight approx. [kg]	Ref. No.	VE	1020	1028	1029	1032	1035	1037	1038	1039	1040	1042	1043	1043.1	1043.3	1045	1052	1054	1056	1057	1061	1062	1064	1074						
1	<b>Suspended platform</b> for use on all TOPIC rung or double step ladders; easy fitting over the rungs or steps		0.8	<b>1016.003</b>		▶	▶			▶	▶	▶	▶							▶			▶	▶									
2	<b>Gutter holder</b> Secure attachment for all ladders		0.5	<b>1016.006</b>						▶	▶			▶	▶						▶												
3	<b>Suspended bag with hook</b> as tool box for all TOPIC rung double ladders	Yellow orange RAL 2000	0.5	<b>1016.014</b>			▶							▶											▶								
4	<b>TOPIC Box</b> for use on all TOPIC rung or double step ladders; easy fitting over the rungs or steps	Silver grey RAL 7001	0.8	<b>1016.021</b>			▶										▶	▶							▶								
5	<b>Wood stile extension set EasyFix</b> 1.25 m (1 pcs.) for wooden double ladders 1020 and 1038 (up to 10 rungs) and the wallpaperer's trestle 1045, fixation material with wing bolts included		1.25	1.9	<b>1016.022</b>		▶																										
			1.65	2.2	<b>1016.023</b>		▶																										
6	<b>Top rollers</b> with rubber tyres to protect the wall surface when extending / retracting ladder, usable on the TOPIC ladders 1035, 1037 and 1040	Anthracite grey RAL 7016	1.5	<b>1016.027</b>																													
7	<b>Suspension hook</b> DIY-assembly, usable on tubes up to d=50 mm, (1 pcs.)		0.1	<b>1016.050</b>																													
8	<b>Ladder shoe for wooden ladder</b> DIY-assembly, fits onto ladders 1053 and 1038 up to 10 rungs and onto wallpaperer's trestles 1045	Yellow orange RAL 2000	0.2	<b>1016.052</b>		▶	2	▶																									
			0.3	<b>1016.053</b>		▶	2	▶																									
9	<b>Cross-piece castors</b> for easy movement of large ladders; easy fitting by large dimensioned wing bolts		0.7	<b>1016.072</b>																													
10	<b>Wall bracket</b> for easy suspension of ladders with suspension hooks, Axial dim. = 640 mm, Wall spacing = 123 mm		2.5	<b>1016.090</b>																													
11	<b>Ladder wall mounting</b> for an ideal storage of ladders on the wall		1.8	<b>1016.092</b>																													
12	<b>Insert hook</b> self-securing, usable on all Layher TOPIC ladders		0.1	<b>1016.100</b>																													
13	<b>Spike</b> For better stability on grass or soil; easy fitting without drilling or riveting. Usable on all TOPIC ladders with Combigrif ladder foot.		0.1	<b>1016.101</b>																													
14	<b>Step attachment</b> can be used with stile height 100 mm of ladders 1037, 1035, 1040	Yellow orange RAL 2000	3.3	<b>1016.103</b>																													
			3.0	<b>1016.763</b>																													
15	<b>TOPIC Stile Extension</b> (1 pcs.) for stile extension on stairways or podia; adjustment area up to 400 mm; easy fitting by 2 large dimensioned wing bolts		64 mm	1.5	<b>1016.108</b>																												
			76 mm	1.7	<b>1016.109</b>																												
			84 mm	1.9	<b>1016.110</b>																												
			100 mm	2.1	<b>1016.111</b>																												
16	<b>Castors for machine step</b>		0.5	<b>1016.751</b>																													

## Spare parts

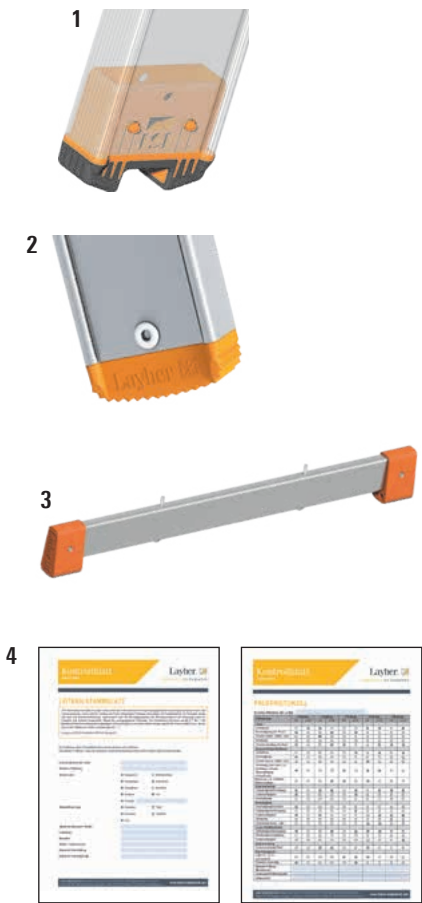

The Layher Combigrip ladder foot is made of a 2-component plastic: a hard inner section (orange) for secure mounting inside the stile, and a soft outer covering (black), non-slip on every floor surface.

That ensures:

- ▶ Play-free mounting in ladder stile.
- ▶ High slipping resistance, for maximum stability of ladders.
- ▶ Long service life – no cutting or reshaping of the foot.

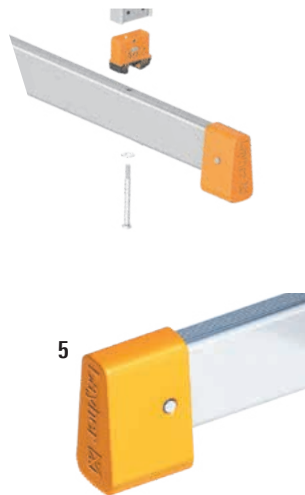

The Layher Combigrip ladder foot ensures easy retrofitting of a ladder cross-piece. The cross-piece is simply inserted into the cutout provided for it in the foot, and then firmly screwed to the stile ends using hexagonal-head screws.

**TIP:** With the Layher Combigrip ladder foot, you automatically comply with the new requirements of DIN EN 131-1, which will specify a cross-piece for simple ladders of 3 metres and more length.



Image can differ from original.

## Pictogram description

Labels acc. to new DIN EN 131-3 – label see pos. 7

	Pay attention to the user manual		Do not use the ladder on an uneven, unstable or fouled surface.		Only ascend and descend the ladder when facing towards it. Grip the ladder tightly during ascent, descent and working.
	Check ladder upon delivery. Visually check the ladder for absence of damage and for safe use prior to every use. Do not use damaged ladders.				
	Remain below the maximum useful load.				Do not use the top three steps / rungs of a simple ladder to stand on.
	Only use the ladders with the included cross-pieces.		Open the ladder completely before use. Locking devices must be fully activated before the ladder is used, if this is not done automatically.		Do not use the top two steps / rungs of a double ladder to stand on without a platform and a holding device for the hand / knee
	Use simple ladders with rungs at the correct angle.				Ladders with this marking are designed for private use only.
	Do not exceed the maximum number of users.		Avoid any work exerting a lateral load on the ladder, for example drilling sideways through solid materials. When using a ladder, do not carry equipment which is heavy and awkward.		Ladders with this marking are designed for both private and professional use.
	Do not use the ladder for bridging purposes.				
	Ladders for access to greater heights must be extended at least 1 metre above the contact point and secured as necessary.				
	Do not climb the ladder with unsuitable shoes.				

Pos.	Description	Dimensions [m]	Weight approx. [kg]	PU	Ref. No.	
1	<b>Combigrip ladder foot</b> of 2-component plastic for secure mounting inside the stile and non-slip on every floor surface	64-mm-stile	0.2	2	6492.810	
		76-mm-stile	0.2	2	6492.811	
		84-mm-stile	0.2	2	6492.812	
		100-mm-stile	0.2	2	6492.813	
2	<b>TOPIC ladder foot</b> for ladder heads and inner ladders of multi-purpose ladders	64-mm-stile	0.3	2	6492.011	
		76-mm-stile	0.3	2	6492.012	
		84-mm-stile	0.3	2	6492.013	
		100-mm-stile	0.4	2	6492.014	
3	<b>Ladder cross-piece</b> for even more safety, easy fitting with the Combigrip ladder foot	1032.008 – 1032.014	1.13	3.0	1016.081	
		1054.006 – 1054.024				
		1042.006 – 1042.018				
		1043.113 – 1043.116				
		1035.006 – 1035.010	0.89	3.0	1016.082	
		1035.012 – 1035.018	1.36	3.0	1016.084	
		1037.014 – 1037.024				
		1040.006 – 1040.008	0.89	3.0	6492.114	
	1040.010	1.13	3.0	6492.115		
	1040.012 – 1040.014	1.36	3.0	6492.116		
4	<b>Ladder control sheet</b> acc. to UVV "Ladders and steps" DGUV Information 208-016 § 29, ladders and steps must be checked to their proper condition. By the ladder control sheet you have a check list for controlling and protocolling.	<a href="https://downloads.layher.com">downloads.layher.com</a>				
5	<b>Foot for cross-piece</b> for all ladder cross-pieces		1.1	2	6492.015	
6	<b>Universal- and check plaquette</b> German operating safety regulations require that ladders are inspected.		0.2	10	6493.002	
7	<b>Pictogram labels as replacement</b> Manual for label replacement is added to the label!	For platform ladder TOPIC 1074		0.01	10	6493.007
		For multifunction ladders 1040, 1056, 1057, 1058		0.01	10	6493.008
		For double ladders 1039, 1043, 1061, 1064, 1043.1		0.01	10	6493.010
		For single ladders 1035, 1037, 1042, 1054, 1060, 1032		0.01	10	6493.011
		Für Holzstehleitern 1028, 1038, 1053, 1020		0.01	10	6493.012
		For wooden single ladders 1029, 1052		0.01	10	6493.013
8	<b>Base widening, kit</b> For telescopic ladder 1058		0.9		1016.175	

## Wooden roofer's ladder 1046

Special ladder in craftsman's quality, curved rungs with recesses for roof hooks. Double-screwed to stiles. In conformity with the regulations of German professional builders' associations. The roofer's ladder 1046 permit a variable operating range up to a roof pitch of 75° and hung in roof hooks. The roofer's ladder 1046 ist equipped with tear-proof polyester straps as breaking cut-out.



Outer width: **365 mm**  
Rung spacing: **280 mm**



### Wooden roofer's ladder 1046

Length [m]	Number of rungs	Weight approx. [kg]	Ref. No.
2.35	8	4.8	<b>1046.108</b>
2.85	10	5.5	<b>1046.110</b>
3.50	12	6.3	<b>1046.112</b>
4.15	14	7.0	<b>1046.114</b>
4.50	16	7.8	<b>1046.116</b>
4.63	18	9.2	<b>1046.118</b>

## Roof ladder as per DIN 4567-4 1051

Layher roof ladders are laid on house roofs for temporary maintenance and inspection work, for example on chimneys or satellite dishes. High-grade roofs are protected from scratching during assembly and use by the unique and EPDM protective section of Layher roof ladders. Layher roof ladders permit a variable operating range up to a roof pitch of 73°.



Clear width: **300 mm**  
Rung spacing: **280 mm**  
Outer width: **340 mm**  
Stile height: **95 mm**



The Layher roof ladders are available in 4 colour variants:

- ▶ Natural aluminium
- ▶ RAL 7016 (Anthracite grey)
- ▶ RAL 8004 (Copper brown)
- ▶ RAL 8011 (Nut brown)

### Roof ladder as per DIN 4567-4 1051

Number of rungs	Weight approx. [kg]	Colour	Ref. No.
7	3.8	Aluminium nat.	<b>1051.007</b>
10	5.5	Aluminium nat.	<b>1051.010</b>
15	8.3	Aluminium nat.	<b>1051.015</b>
7	3.8	RAL 8004	<b>1051.107</b>
10	5.5	RAL 8004	<b>1051.110</b>
15	8.3	RAL 8004	<b>1051.115</b>
7	3.8	RAL 8011	<b>1051.207</b>
10	5.5	RAL 8011	<b>1051.210</b>
15	8.3	RAL 8011	<b>1051.215</b>
7	3.8	RAL 7016	<b>1051.307</b>
10	5.5	RAL 7016	<b>1051.310</b>
15	8.3	RAL 7016	<b>1051.315</b>



Connect the roof ladders using the connecting straps, Ref. No. 1049.x03. The bolts, washers and locking nuts are included. Use four bolts per strap. At least two safety hooks must be used. Up to three ladders can be joined without an additional roof hook and fastening bracket being needed.

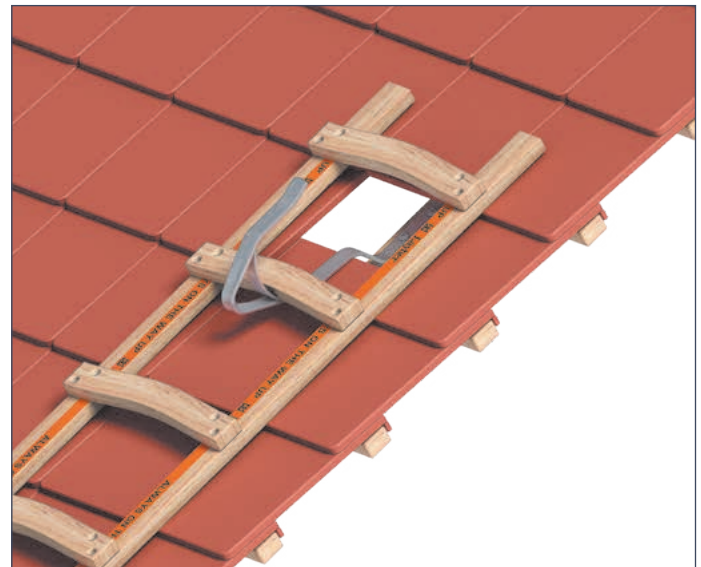
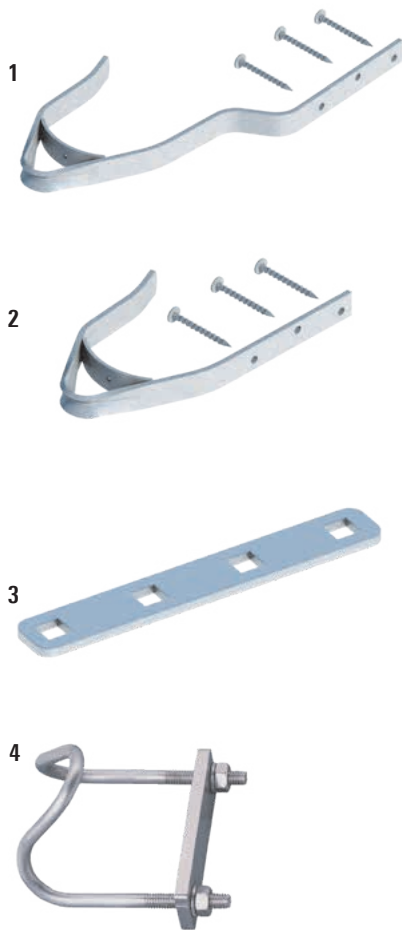

Exemplary application of the safety hook model Z (Pos. 1)



Pos.	Description	Dimensions [m]	Weight approx. [kg]	PU	Ref. No.
1	<b>Safety hook, model Z</b> according to DIN EN 517-Type B For use on tiled roofs, incl. nails	steel galvanized	0.46 x 0.23 x 0.03	0.9	<b>1049.011</b> 📦
		Copper brown RAL 8004		0.9	<b>1049.111</b> 📦
		Nut brown RAL 8011		0.9	<b>1049.211</b> 📦
		Anthracite grey RAL 7016		0.9	<b>1049.311</b> 📦
2	<b>Safety hook, model B</b> according to DIN EN 517-Type A For use on slate roofs, incl. nails	steel galvanized	0.33 x 0.18 x 0.03	0.8	<b>1049.012</b> 📦
		Copper brown RAL 8004		0.8	<b>1049.112</b> 📦
		Nut brown RAL 8011		0.8	<b>1049.212</b> 📦
		Anthracite grey RAL 7016		0.8	<b>1049.312</b> 📦
3	<b>Connecting strap</b> Including bolts, washers and nuts of stainless steel	Alu natural	0.20 x 0.02 x 0.005	0.5	<b>2</b> 📦 <b>1049.003</b> 📦
		Copper brown RAL 8004		0.5	<b>2</b> 📦 <b>1049.103</b> 📦
		Nut brown RAL 8011		0.5	<b>2</b> 📦 <b>1049.203</b> 📦
		Anthracite grey RAL 7016		0.5	<b>2</b> 📦 <b>1049.303</b> 📦
4	<b>Fastening bracket</b> according to DIN 18160-5, galvanized			0.1	<b>1049.000</b> 📦

Instructions for assembly and use can be found at [mediathek.layher-steigtechnik.com](http://mediathek.layher-steigtechnik.com)

The roof ladder *TOPIC* 1051 plus the above accessory parts (apart from the fastening bracket) are available in 4 colour variants:

Alu natural or galvanized	RAL 8004 Copper brown	RAL 8011 Nut brown	RAL 7016 Anthracite grey
------------------------------	--------------------------	-----------------------	-----------------------------

# LAYHER ACCESSES



## Different inclinations

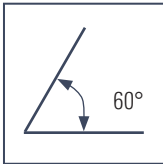
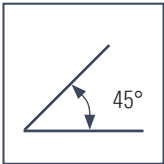

## Different step types (see accessories)

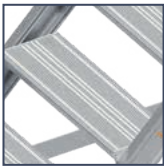

Standard steps of aluminium with grooved surface  
Slip resistance:  
R12 in step direction



Alternative steps made of steel grating\*  
Slip resistance: R11



Alternative steps made of aluminium grating\*  
Slip resistance: R11



Alternative steps made of steel perforated plate\*  
Slip resistance: R11



Alternative steps made of aluminium perforated plate\*  
Slip resistance: R11

**R12**  
Slip resistance  
in step direction

\* Delivery time on request



## Different step widths

- ▶ 0.60 m and 0.80 m as standard
- ▶ 1.00 m on request

Standard accesses with inclination of 45° and 60° and step widths of 0.60 m and 0.80 m as listed in the catalogue are quickly available (**15 workdays after receipt of order**). Further sizes, designs and inclinations are possible on request.

## Easy fixing of movement direction



Wheels with lock to immobilise the wheel and fork head can be fixed using a direction lock in the access direction or sideways direction.



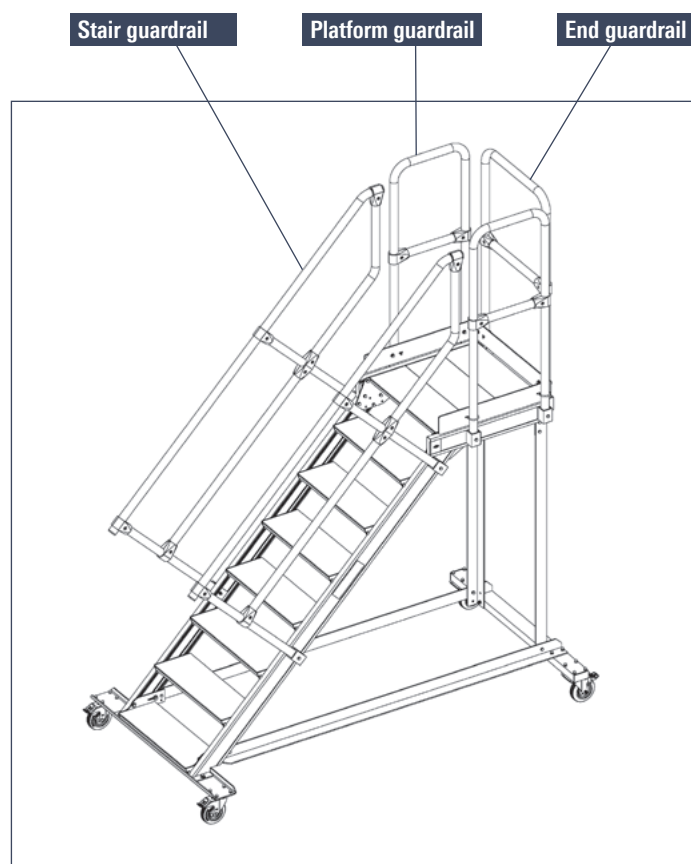
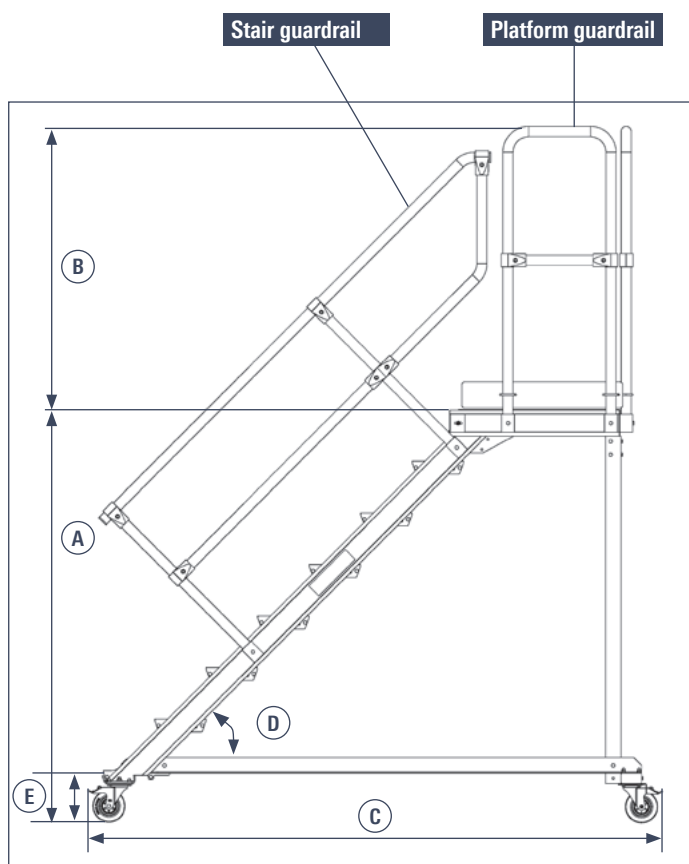

(A) Platform height

(B) Guardrail height

(C) Base-to-base distance

(D) Inclination

(E) Riser for 45° = 200 mm / for 60° = 240 mm

(F) Step width

(G) Width

(H) Wheel set width

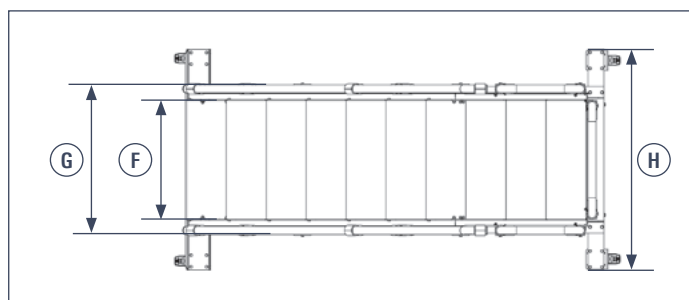

**TECHNICAL DATA:**

- ▶ Step load 150 kg
- ▶ Total load 300 kg

**THE BENEFITS FOR YOU:**

- ▶ 200 mm deep steps with grooved aluminium surface with slip resistance R12 in the step direction (included in the price in the standard version).
- ▶ Handrails and guardrails of 40 mm round tube with cast aluminium connectors, orange, powder-coated.
- ▶ High flexibility for expansions, additions and adaptations thanks to the "new" modular principle.
- ▶ Separate ordering possible for handrails, platform guardrails, end

- guardrails and accessories.
- ▶ Quick and easy assembly and dismantling of stair guardrails and other guard rails or of additional stair guardrail or other guardrail as preassembled units at no extra charge.
- ▶ To aid decision-making, quick technical support in the form of sketches or drawings can be supplied.



Stair type	Alu start-stairway 110	Alu stairway 111	Alu stairway with platform 112	Alu maintenance platform 113	Alu bridging stairway 114
<b>Description</b>	Ideal for machinery access with a comfortable stance.	Fixed access to higher levels.	Fixed access to higher levels with large platform, e.g. for door openings.	Mobile access to higher-level shelves or for maintenance work at greater heights.	Machinery crossover with ample width.
<b>Step width</b>	0.60 m or 0.80 m	0.60 m or 0.80 m	0.60 m or 0.80 m	0.60 m or 0.80 m	0.60 m or 0.80 m
<b>Width</b>	<b>0.60 m</b>	0.68 m, 0.87 m*	0.73 m**	see table 113	0.79 m**
	<b>0.80 m</b>	0.88 m, 1.07 m*	0.93 m**		0.99 m**
<b>Step length</b>	200 mm	200 mm	200 mm	200 mm	200 mm
<b>Inclination</b>	45°	45° or 60°	45° or 60°	45° or 60°	45° or 60°
<b>Platform length</b>	0.40 m	0.20 m	0.60 m	0.60 m	0.80 m
<b>Riser</b>	<b>45°</b>	200 mm	200 mm	200 mm	200 mm
	<b>60°</b>		240 mm	240 mm	240 mm
<b>Max. step load</b>	150 kg	150 kg	150 kg	150 kg	150 kg
<b>Max. total load</b>	300 kg	300 kg	300 kg	300 kg	300 kg

All dimensions are guideline values. Subject to technical modification. Delivery exclusively in accordance with our currently valid General Terms of Sale. Delivery incl. assembly drawing. Cannot be returned.

\* Dimensions including crosspiece

\*\* Width with stair guardrail on one side

## Aluminium access steps, fixed or rolling 110

For loading of containers, servicing machinery etc.

Special stile made of strong aluminium section. Step profile grooved for sure footing.

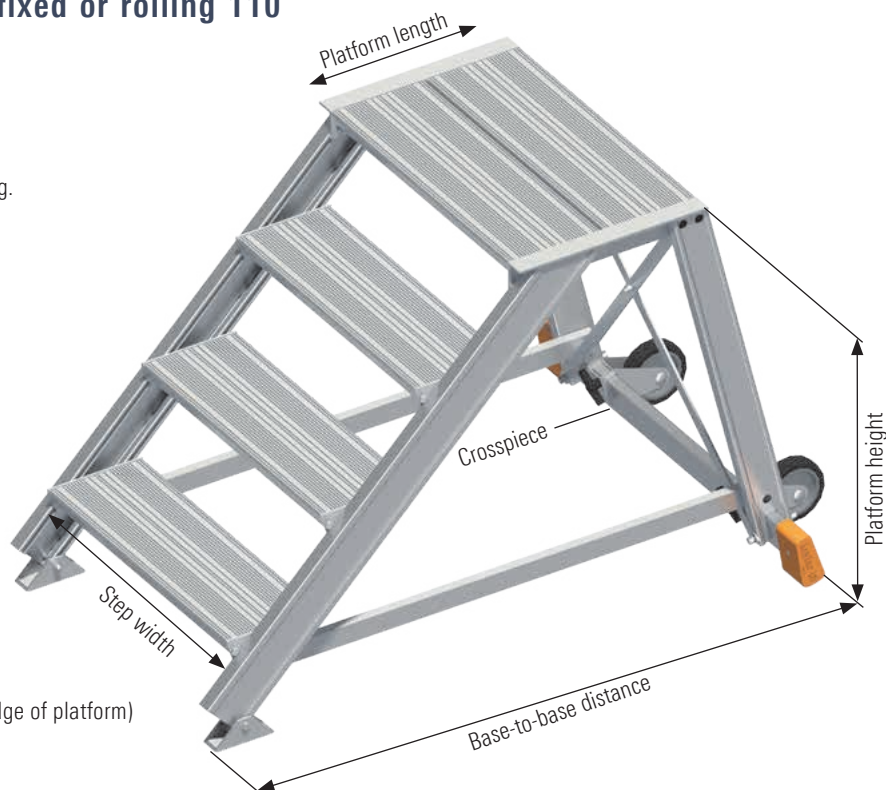

**Platform height:**

Max. 0.99 m (dimension from floor to top edge of platform)

**Platform length:**

0.40 m

**Width:**

Step width + 0.08 m

**Crosspiece:**

For sure footing:

With step width 0.60 m = 0.87 m

With step width 0.80 m = 1.07 m

**Crosspiece wheels (optional):**

For moving the access steps like a wheelbarrow

Inclination	Step width [mm]	Platform height [m]	0.40	0.60	0.80	1.00
45°		Number of steps	2	3	4	5
		Base-to-base distance [m]	0.75	1.0	1.25	1.5
	600	Weight [kg]	10.3	13.4	16.6	19.9
		Ref. No.	1106.702	1106.703	1106.704	1106.705
		Weight [kg]	11.9	15.4	18.9	22.6
			Ref. No.	1108.702	1108.703	1108.704

Delivery exclusively in accordance with our currently valid General Terms of Sale. Delivery incl. assembly drawing. Cannot be returned. Component weights are subject to fluctuations due to tolerances and may therefore diverge from what is specified.

## Aluminium stair 111

A safe and permanently fitted access. Wherever material, equipment and machinery have to be stored or operated at a height. Rapid working is assured by convenient and effortless movement even with loads.

**Platform height:**

Max. 3.84 m (dimension from floor to top edge of top step)

**Width:**

Step width + 0.13 m with stair guardrail on one side  
Step width + 0.17 m with stair guardrail on both sides

**Stair guardrail/guardrail:**

The standard scope of delivery includes a stair guardrail (which can be optionally fitted either left or right). DIN EN ISO 14122-3 must be complied with. Accordingly, for a stairway with a 45° inclination a stair guardrail is specified for **at least** one side. For a 45° angle and a wall clearance > 200 mm, or for 60°, a handrail must be provided on both sides.

**Base-to-base distance:**

Dimension from front edge of stair to wall

**Hole for fastening strap:**

9 mm

High flexibility thanks to modular principle

Quick and easy assembly thanks to delivery of pre-assembled units

Function for fitting and extending the guardrail included in the price

R12 grooved aluminium steps included in the price

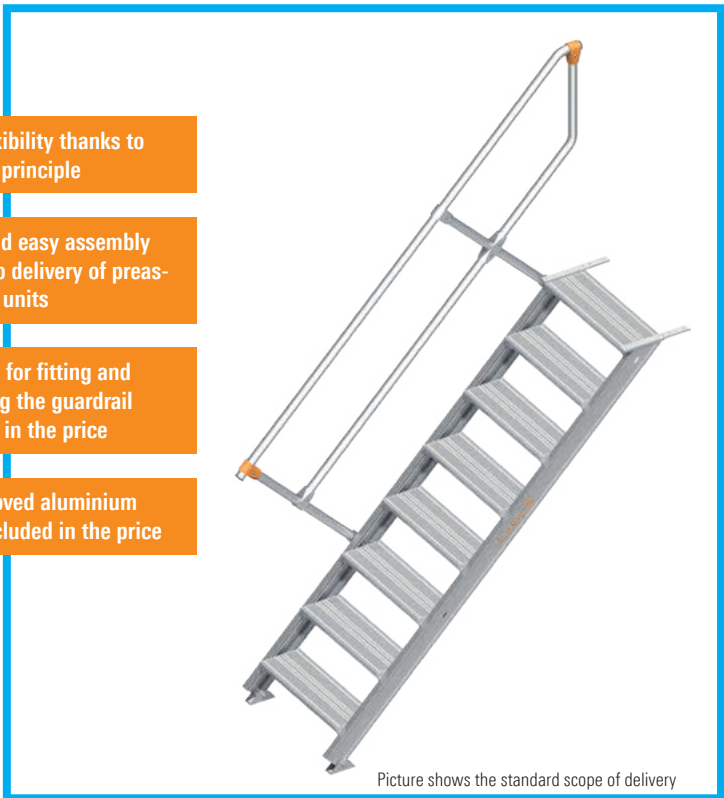

Picture shows the standard scope of delivery

The safe transfer of the loads into the structure or the building ground must be approved by the customer.

Inclination	Step width [mm]	Platform height [m]	0.60	0.80	1.00	1.20	1.40	1.60	1.80	2.00	2.20
45°	600	Number of steps	3	4	5	6	7	8	9	10	11
		Base-to-base distance [m]	0.67	0.87	1.07	1.27	1.47	1.67	1.87	2.07	2.27
		Weight [kg]	14.5	17.0	19.7	22.6	25.5	28.7	33.3	34.6	39.3
	800	Ref. No.	1116.403	1116.404	1116.405	1116.406	1116.407	1116.408	1116.409	1116.410	1116.411
		Weight [kg]	15.7	18.7	21.8	25.1	28.4	32.0	37.1	40.4	44.0
		Ref. No.	1118.403	1118.404	1118.405	1118.406	1118.407	1118.408	1118.409	1118.410	1118.411
Extra charge for 2nd stair guardrail		Weight [kg]	6.0	6.1	6.3	6.7	7.1	7.8	10.0	10.4	11.0
		Ref. No.	1110.403	1110.404	1110.405	1110.406	1110.407	1110.408	1110.409	1110.410	1110.411
Inclination	Step width [mm]	Platform height [m]	0.72	0.96	1.20	1.44	1.68	1.92	2.16	2.40	2.64
60°	600	Number of steps	3	4	5	6	7	8	9	10	11
		Base-to-base distance [m]	0.522	0.661	0.799	0.938	1.076	1.215	1.354	1.493	1.632
		Weight [kg]	14.3	16.9	19.6	22.2	25.0	28.1	32.4	35.4	38.3
	800	Ref. No.	1116.603	1116.604	1116.605	1116.606	1116.607	1116.608	1116.609	1116.610	1116.611
		Weight [kg]	15.5	18.6	21.7	24.8	28.0	31.4	36.2	39.6	43.0
		Ref. No.	1118.603	1118.604	1118.605	1118.606	1118.607	1118.608	1118.609	1118.610	1118.611
Extra charge for 2nd stair guardrail		Weight [kg]	5.8	6.0	6.2	6.4	6.7	7.3	9.2	9.7	10.2
		Ref. No.	1110.603	1110.604	1110.605	1110.606	1110.607	1110.608	1110.609	1110.610	1110.611

Intermediate heights are possible on request when the appropriate platform is specified. Quotation and Technical Data Sheet will follow within 72 hours of receipt of the enquiry. All dimensions are guideline values. Subject to technical modification. Delivery exclusively in accordance with our currently valid General Terms of Sale. Delivery incl. assembly drawing. Cannot be returned. Component weights are subject to fluctuations due to tolerances and may therefore diverge from what is specified.

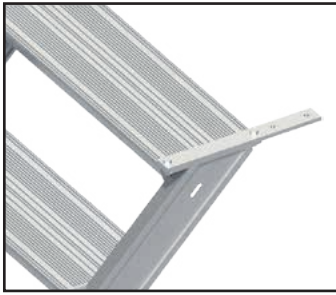

Detailed view of fastening strap

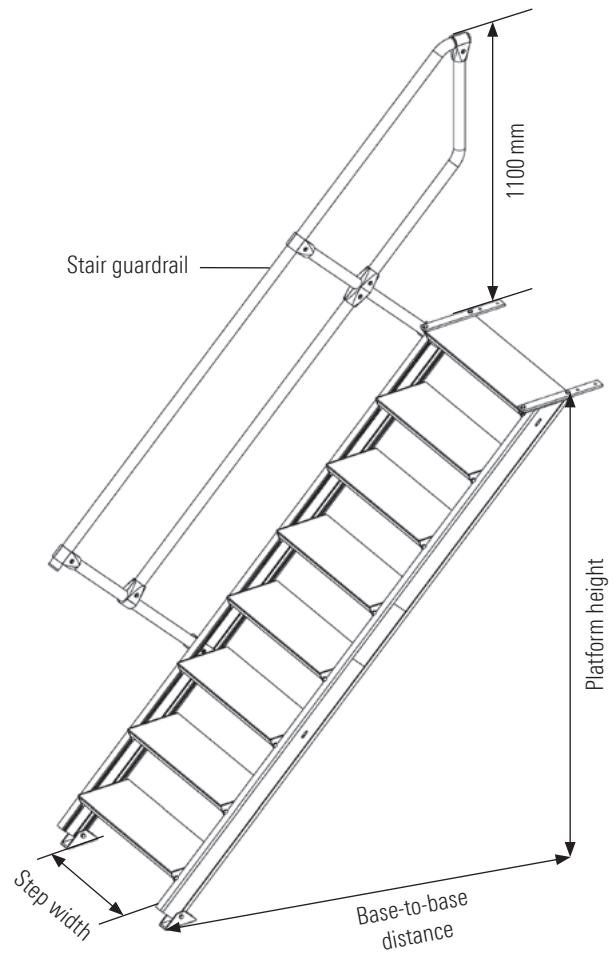

Inclination	Step width [mm]	Platform height [m]	2.40	2.60	2.80	3.00	3.20	3.40	3.60	3.80
45°	600	Number of steps	12	13	14	15	16	17	18	19
		Base-to-base distance [m]	2.47	2.67	2.87	3.07	3.27	3.47	3.67	3.87
		Weight [kg]	42.4	47.0	64.8	69.0	74.6	78.8	82.9	87.0
		Ref. No.	1116.412	1116.413	1116.414	1116.415	1116.416	1116.417	1116.418	1116.419
	800	Weight [kg]	47.5	52.5	70.7	75.3	81.4	86.0	90.5	95.0
		Ref. No.	1118.412	1118.413	1118.414	1118.415	1118.416	1118.417	1118.418	1118.419
Extra charge for 2nd stair guardrail		Weight [kg]	11.6	13.7	14.2	14.8	16.9	17.5	18.0	18.5
		Ref. No.	1110.412	1110.413	1110.414	1110.415	1110.416	1110.417	1110.418	1110.419
Inclination	Step width [mm]	Platform height [m]	2.88	3.12	3.36	3.60	3.84			
60°	600	Number of steps	12	13	14	15	16			
		Base-to-base distance [m]	1.77	1.9	2.05	2.19	2.32			
		Weight [kg]	41.4	45.8	63.5	67.5	71.5			
		Ref. No.	1116.612	1116.613	1116.614	1116.615	1116.616			
	800	Weight [kg]	46.5	51.3	69.4	73.8	78.3			
		Ref. No.	1118.612	1118.613	1118.614	1118.615	1118.616			
Extra charge for 2nd stair guardrail		Weight [kg]	10.8	12.7	13.2	13.7	14.2			
		Ref. No.	1110.612	1110.613	1110.614	1110.615	1110.616			

## Alu stairway with platform 112

Can be fixed to buildings as an emergency exit, at machines, as a raised workplace, etc.

### Platform height:

Max. 3.84 m (dimension from floor to top edge of platform)

### Platform length:

0.60 m

### Width:

Step width + 0.13 m with stair guardrail on one side

Step width + 0.17 m with stair guardrail on both sides

### Stair guardrail / platform guardrail:

The standard scope of delivery includes a stair guardrail and a platform guardrail (both of which can be optionally fitted either left or right). DIN EN ISO 14122-3 must be complied with. Accordingly, for a stairway with a 45° inclination a stair guardrail is specified for **at least** one side. For a 45° angle and a wall clearance > 200 mm, or for 60°, a handrail must be provided on both sides.

### Base-to-base distance:

Dimension from front edge of stair to wall

### Hole for fastening strap:

9 mm

High flexibility thanks to modular principle

Quick and easy assembly thanks to delivery of pre-assembled units

Function for fitting and extending the guardrail included in the price

R12 grooved aluminium steps included in the price



Picture shows the standard scope of delivery

**The safe transfer of the loads into the structure or the building ground must be approved by the customer.**

Inclination	Step width [mm]	Platform height [m]	0.60	0.80	1.00	1.20	1.40	1.60	1.80	2.00	2.20
45°	600	Number of steps	3	4	5	6	7	8	9	10	11
		Base-to-base distance [m]	1.07	1.27	1.47	1.67	1.87	2.07	2.27	2.47	2.67
		Weight [kg]	25.0	27.7	30.4	33.0	36.0	39.1	43.7	46.7	49.9
		Ref. No.	1126.403	1126.404	1126.405	1126.406	1126.407	1126.408	1126.409	1126.410	1126.411
	800	Weight [kg]	27.1	30.2	33.3	36.4	39.8	43.3	48.3	51.7	55.4
		Ref. No.	1128.403	1128.404	1128.405	1128.406	1128.407	1128.408	1128.409	1128.410	1128.411
Extra charge for 2nd stair guardrail		Weight [kg]	5.7	5.9	6.1	6.3	6.8	7.4	9.5	10.0	10.8
		Ref. No.	1160.403	1160.404	1160.405	1160.406	1160.407	1160.408	1160.409	1160.410	1160.411
Inclination	Step width [mm]	Platform height [m]	0.72	0.96	1.20	1.44	1.68	1.92	2.16	2.40	2.64
60°	600	Number of steps	3	4	5	6	7	8	9	10	11
		Base-to-base distance [m]	0.93	1.07	1.21	1.35	1.48	1.62	1.76	1.90	2.04
		Weight [kg]	24.8	27.3	30.1	32.6	35.4	38.5	42.8	45.8	48.7
		Ref. No.	1126.603	1126.604	1126.605	1126.606	1126.607	1126.608	1126.609	1126.610	1126.611
	800	Weight [kg]	26.9	29.9	33.0	36.0	39.2	42.7	47.5	50.9	54.2
		Ref. No.	1128.603	1128.604	1128.605	1128.606	1128.607	1128.608	1128.609	1128.610	1128.611
Extra charge for 2nd stair guardrail		Weight [kg]	5.4	5.5	5.8	5.9	6.2	6.8	8.7	9.2	9.7
		Ref. No.	1160.603	1160.604	1160.605	1160.606	1160.607	1160.608	1160.609	1160.610	1160.611

Intermediate heights are possible on request when the appropriate platform is specified. Quotation and Technical Data Sheet will follow within 72 hours of receipt of the enquiry. All dimensions are guideline values. Subject to technical modification. Delivery exclusively in accordance with our currently valid General Terms of Sale. Delivery incl. assembly drawing. Cannot be returned. Component weights are subject to fluctuations due to tolerances and may therefore diverge from what is specified.

**EXTRA CHARGE FOR PLATFORM EXTENSION PER 200 MM  
PLATFORM EXPANDABLE TO MAX. 1.20 M**



**Step width 0.60 m**  
Ref. No. 1152.602

**Step width 0.80 m**  
Ref. No. 1152.802

**EXTRA CHARGE FOR PLATFORM GUARDRAIL (IN COMBINATION WITH  
THE ORDER FOR AN ALUMINIUM STAIR WITH PLATFORM 112)**

Ref. No. 1161.000

**EXTRA CHARGE FOR END GUARD RAIL (IN COMBINATION WITH THE  
ORDER FOR AN ALUMINIUM STAIR WITH PLATFORM 112)**

**Step width 0.60 m**  
Ref. No. 1162.000

**Step width 0.80 m**  
Ref. No. 1163.000

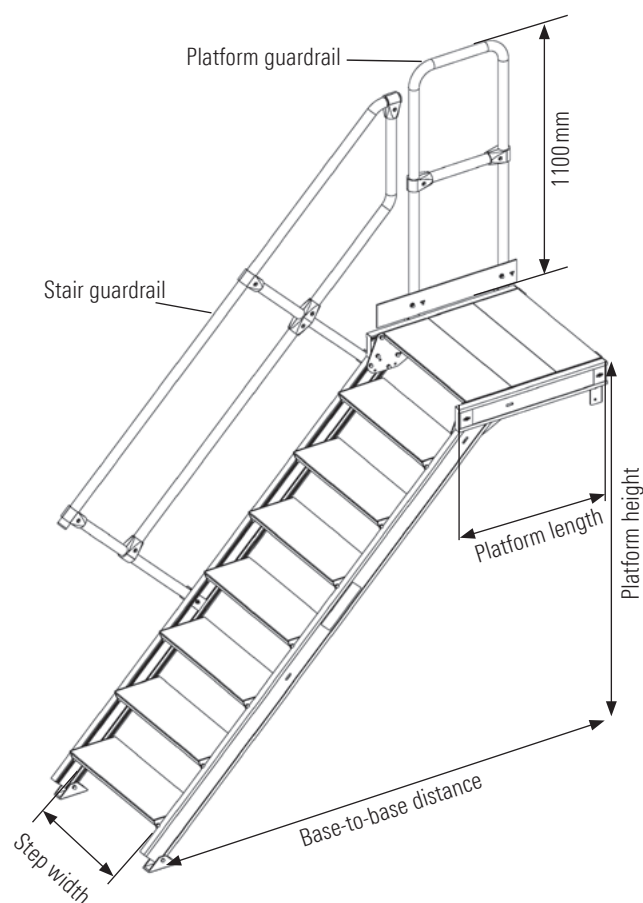

Inclination	Step width [mm]	Platform height [m]	2.40	2.60	2.80	3.00	3.20	3.40	3.60	3.80
45°	600	Number of steps	12	13	14	15	16	17	18	19
		Base-to-base distance [m]	2.87	3.07	3.27	3.47	3.67	3.87	4.07	4.27
		Weight [kg]	52.7	57.4	74.7	78.8	83.0	88.6	92.8	96.9
		Ref. No.	1126.412	1126.413	1126.414	1126.415	1126.416	1126.417	1126.418	1126.419
	800	Weight [kg]	58.6	63.7	81.5	86.0	90.6	96.7	101.3	105.8
		Ref. No.	1128.412	1128.413	1128.414	1128.415	1128.416	1128.417	1128.418	1128.419
Extra charge for 2nd stair guardrail		Weight [kg]	11.1	13.3	13.8	14.3	14.9	17.0	17.6	18.1
		Ref. No.	1160.412	1160.413	1160.414	1160.415	1160.416	1160.417	1160.418	1160.419
Inclination	Step width [mm]	Platform height [mm]	2.88	3.12	3.36	3.60	3.84			
60°	600	Number of steps	12	13	14	15	16			
		Base-to-base distance [m]	2.17	2.30	2.45	2.59	2.73			
		Weight [kg]	51.8	56.2	73.4	77.5	81.5			
		Ref. No.	1126.612	1126.613	1126.614	1126.615	1126.616			
	800	Weight [kg]	57.7	62.5	80.2	84.7	89.1			
		Ref. No.	1128.612	1128.613	1128.614	1128.615	1128.616			
Extra charge for 2nd stair guardrail		Weight [kg]	10.3	12.2	12.7	13.2	13.7			
		Ref. No.	1160.612	1160.613	1160.614	1160.615	1160.616			

## Alu maintenance platform 113

Versatile servicing device for machinery, containers, trucks, buses, shelving systems etc. that do not permit the attachment of permanent equipment.

### Platform height:

Max. 3.60 m (dimension from floor to top edge of platform)

### Platform length:

0.60 m

### Width:

Step width + 0.12 m with stair guardrail on one side

Step width + 0.17 m with stair guardrail on both sides

### Stair guardrail/guardrail:

The standard scope of supply includes all-round guardrails, in each case with the following parts: stair guardrail on both sides of the stair, platform guardrail on both sides, and the respective end guardrail. The parts can be fitted or removed to suit the situation on the spot, for example to allow crossover to adjacent structures at the end or at the sides. DIN EN ISO 14122-3 must be complied with here. Accordingly, for a stairway with a 45° inclination a stair guardrail is specified for **at least** one side. For a 45° angle and a wall clearance > 200 mm, or for 60°, a handrail must be provided on both sides.

### Crosspiece:

For sure footing (see table of wheel set widths for dimensions)

High flexibility thanks to modular principle

Quick and easy assembly thanks to delivery of pre-assembled units

Function for fitting and extending the guardrail included in the price

R12 grooved aluminium steps included in the price



Picture shows the standard scope of delivery

Inclination	Step width [mm]	Platform height [m]	Supplied in the fully assembled state			Only guardrails have to be fitted on the spot					
			0.60	0.80	1.00	1.20	1.40	1.60	1.80	2.00	2.20
45°	600	Number of steps	3	4	5	6	7	8	9	10	11
		Base-to-base distance [m]	1.23	1.43	1.63	1.83	2.03	2.23	2.43	2.63	2.83
		Weight [kg]	54.9	59.1	63.5	67.7	72.9	77.9	85.8	90.8	97.7
		Wheel set width [m]	0.94	0.94	1.00	1.00	1.10	1.10	1.10	1.15	1.15
	Ref. No.	1136.403	1136.404	1136.405	1136.406	1136.407	1136.408	1136.409	1136.410	1136.411	
	800	Weight [kg]	58.7	63.2	68.4	72.9	78.4	83.8	92.2	97.8	105.1
		Wheel set width [m]									
		Ref. No.	1138.403	1138.404	1138.405	1138.406	1138.407	1138.408	1138.409	1138.410	1138.411
Inclination	Step width [mm]	Platform height [m]	0.72	0.96	1.20	1.44	1.68	1.92	2.16	2.40	2.64
60°	600	Number of steps	3	4	5	6	7	8	9	10	11
		Base-to-base distance [m]	1.11	1.25	1.38	1.53	1.66	1.8	1.94	2.08	2.22
		Weight [kg]	54.6	58.5	63.1	67.4	71.7	76.6	84.3	91.5	96.4
		Wheel set width [m]	0.94	0.94	1.00	1.10	1.10	1.15	1.25	1.25	1.25
	Ref. No.	1136.603	1136.604	1136.605	1136.606	1136.607	1136.608	1136.609	1136.610	1136.611	
	800	Weight [kg]	58.4	62.7	67.9	72.4	77.2	82.3	90.8	98.5	103.8
		Wheel set width [m]									
		Ref. No.	1138.603	1138.604	1138.605	1138.606	1138.607	1138.608	1138.609	1138.610	1138.611

Intermediate heights are possible on request when the appropriate platform is specified. Quotation and Technical Data Sheet will follow within 72 hours of receipt of the enquiry. All dimensions are guideline values. Subject to technical modification. Delivery exclusively in accordance with our currently valid General Terms of Sale. Delivery incl. assembly drawing. Cannot be returned. Component weights are subject to fluctuations due to tolerances and may therefore diverge from what is specified.



**EXTRA CHARGE FOR PLATFORM EXTENSION PER 200 MM  
PLATFORM EXPANDABLE TO MAX. 1.20 M**



**Step width 0.60 m**  
Ref. No. 1152.602

**Step width 0.80 m**  
Ref. No. 1152.802

**REDUCED PRICE FOR PLATFORM GUARDRAIL**

Ref. No. 1161.000

**REDUCED PRICE FOR END GUARD RAIL**

**Step width 0.60 m**  
Ref. No. 1162.000

**Step width 0.80 m**  
Ref. No. 1163.000

**EXTRA CHARGE FOR REDUCTION OF RUNNING GEAR WIDTH**

Reduction of the standard wheel set width up to minimum flush width and without lateral projection at the sides, taking into account the ballasting then necessary

Delivery time and data on required ballasting: on request!

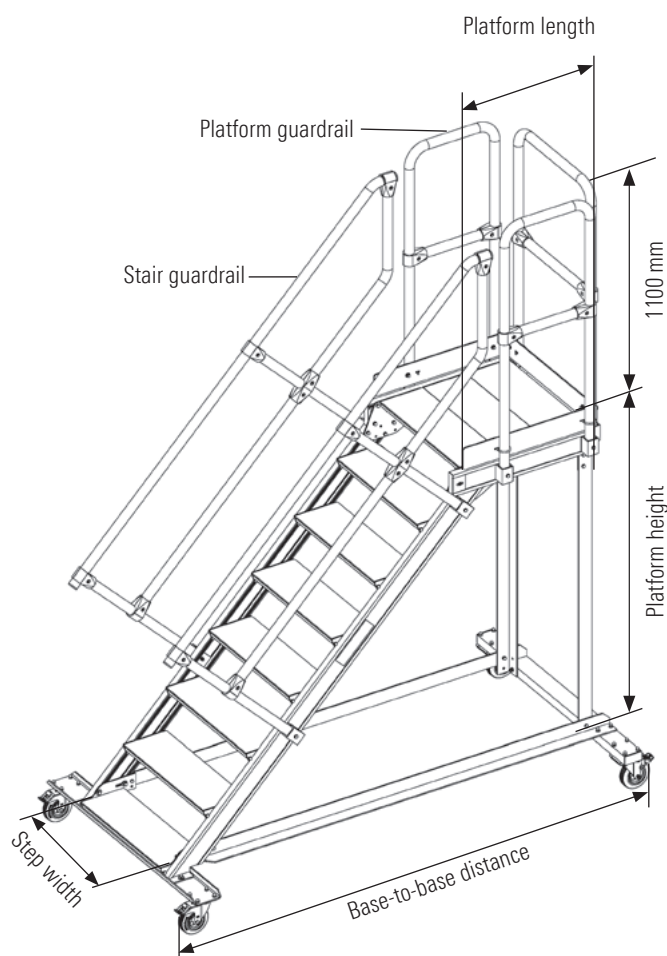

Inclination	Step width [mm]	Platform height [m]	2.40	2.60	2.80	3.00
45°	600	Number of steps	12	13	14	15
		Base-to-base distance [m]	3.03	3.23	3.43	3.63
		Weight [kg]	103.0	111.5	130.4	136.6
	800	Wheel set width [m]	1.25	1.25	1.30	1.30
		Ref. No.	1136.412	1136.413	1136.414	1136.415
		Weight [kg]	110.9	119.8	138.5	145.4
60°	600	Wheel set width [m]	1.50	1.50	1.50	1.50
		Ref. No.	1138.412	1138.413	1138.414	1138.415
		Weight [kg]	101.5	109.4	128.7	135.2
	800	Wheel set width [m]	1.25	1.30	1.40	1.50
		Ref. No.	1136.612	1136.613	1136.614	1136.615
		Weight [kg]	109.3	117.9	137.1	144.0
60°	600	Wheel set width [m]	1.50	1.60	1.60	1.70
		Ref. No.	1138.612	1138.613	1138.614	1138.615
		Weight [kg]	101.5	109.4	128.7	135.2
	800	Wheel set width [m]	1.25	1.30	1.40	1.50
		Ref. No.	1136.612	1136.613	1136.614	1136.615
		Weight [kg]	109.3	117.9	137.1	144.0



Further variants on request

Wheels with lock to immobilise the wheel and fork head can be fixed using a direction lock in the access direction or side-ways direction.

## Alu bridging stairway, statical 114

For crossovers of containers, machinery, conveyor belts, assembly lines etc. Fastened using angled mounting sections to bottom of stair; standard version.

**Platform height:**

Max. 3.30 m (dimension from floor to top edge of platform)

**Clear height vertical:**

Platform height – x (see sketch on page 43)

**Width:**

Step width + 0.19 m with stair guardrail on one side and on both sides

**Clear width:**

45° ≥ 0.75 m

60° ≤ 0.65 m

**Stair guardrail / platform guardrail:**

The standard scope of delivery includes per crossover a stair guardrail on one side and a platform guardrail (both of which can be optionally fitted either left or right). DIN EN ISO 14122-3 must be complied with. Accordingly, for a stairway with a 45° inclination a stair guardrail is specified for **at least** one side. For a 45° angle and a wall clearance > 200 mm, or for 60°, a handrail must be provided on both sides.

**Platform length:**

0.80 m

**fastening bracket hole:**

9 mm

High flexibility thanks to modular principle

Quick and easy assembly thanks to delivery of pre-assembled units

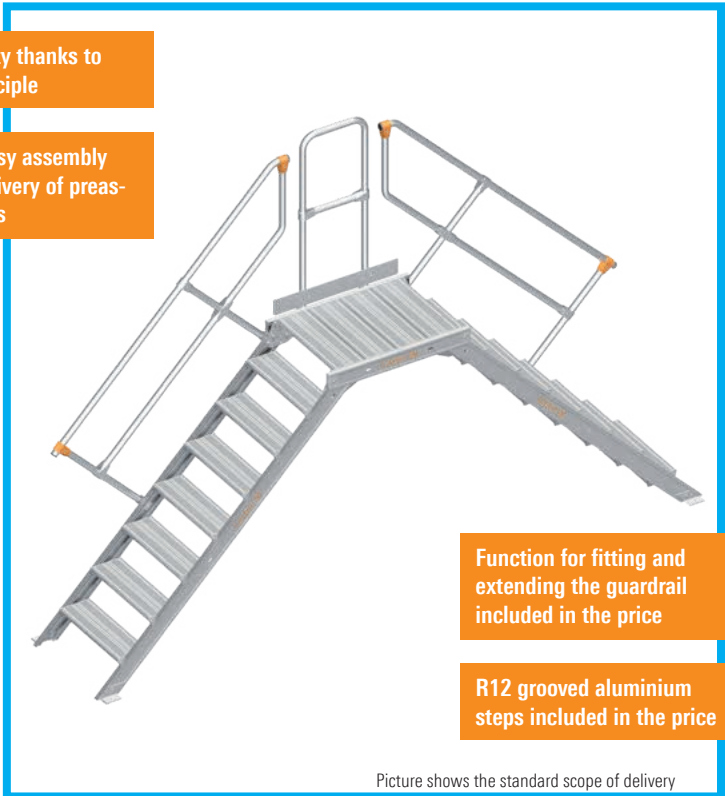

Function for fitting and extending the guardrail included in the price

R12 grooved aluminium steps included in the price

Picture shows the standard scope of delivery

**Aluminium bridging stairways must be fastened to the floor (e.g. dowelled).**

**The safe transfer of the loads into the structure or the building ground must be approved by the customer.**

Inclination	Step width [mm]	Platform height [m]	Supplied in the fully assembled state			Only guardrails have to be fitted on the spot				
			0.60	0.80	1.00	1.20	1.40	1.60	1.80	2.00
45°	600	Number of steps	3	4	5	6	7	8	9	10
		Base-to-base distance [m]	1.90	2.30	2.70	3.10	3.50	3.90	4.30	4.70
		Weight [kg]	40.0	45.4	50.7	56.1	62.1	68.2	77.4	83.3
		Ref. No.	1146.403	1146.404	1146.405	1146.406	1146.407	1146.408	1146.409	1146.410
	800	Weight [kg]	43.4	49.6	55.8	62.0	68.8	75.8	85.8	92.6
		Ref. No.	1148.403	1148.404	1148.405	1148.406	1148.407	1148.408	1148.409	1148.410
Extra charge per Stair guardrail		Weight [kg]	5.7	5.9	6.1	6.3	6.8	7.4	9.5	10.0
		Ref. No.	1160.403	1160.404	1160.405	1160.406	1160.407	1160.408	1160.409	1160.410

Intermediate heights are possible on request when the appropriate platform is specified. Quotation and Technical Data Sheet will follow within 72 hours of receipt of the enquiry. All dimensions are guideline values. Subject to technical modification. Delivery exclusively in accordance with our currently valid General Terms of Sale. Delivery incl. assembly drawing. Cannot be returned. Component weights are subject to fluctuations due to tolerances and may therefore diverge from what is specified.

**EXTRA CHARGE FOR PLATFORM EXTENSION PER 200 MM  
PLATFORM EXPANDABLE TO MAX. 1.20 M**



**Step width 0.60 m**  
Ref. No. 1152.602

**Step width 0.80 m**  
Ref. No. 1152.802

**EXTRA CHARGE FOR PLATFORM GUARDRAIL (IN COMBINATION WITH  
THE ORDER FOR AN ALUMINIUM STAIR 114)**

Ref. No. 1141.000

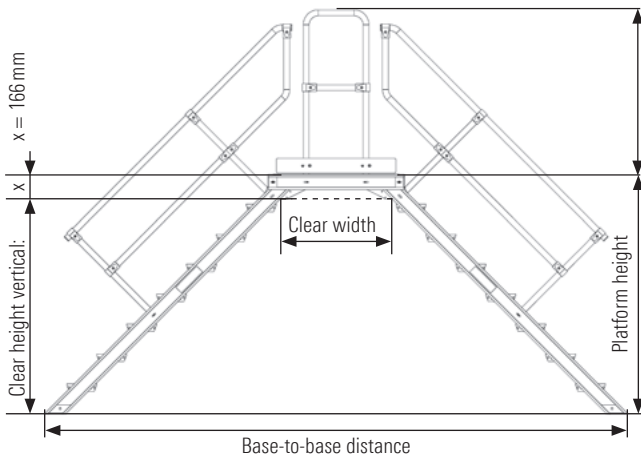
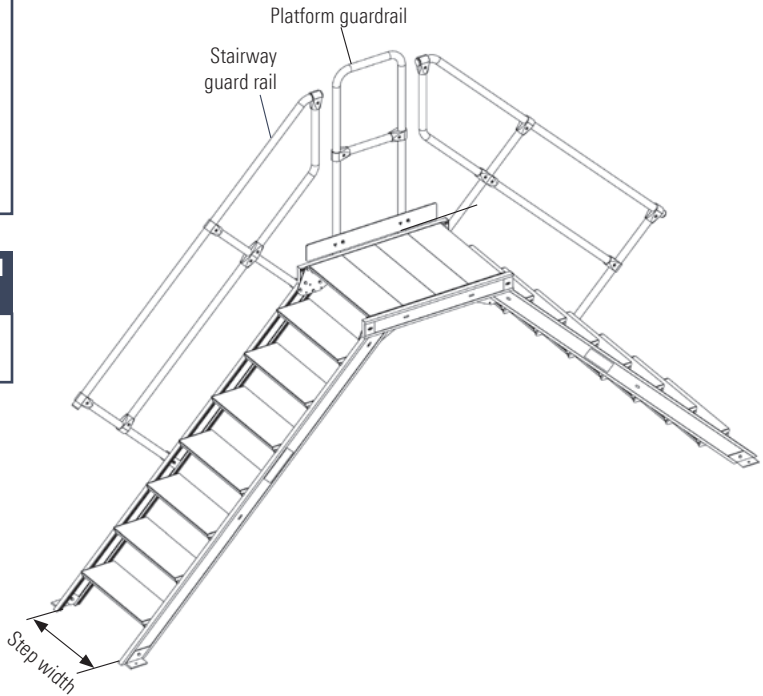

Inclination	Step width [mm]	Platform height [mm]	Supplied in the fully assembled state			Only guardrails have to be fitted on the spot				
			0.72	0.96	1.20	1.44	1.68	1.92	2.16	2.40
60°	600	Number of steps	3	4	5	6	7	8	9	10
		Base-to-base distance [m]	1.52	1.79	2.07	2.35	2.63	2.90	3.18	3.46
		Weight [kg]	39.1	44.2	49.7	54.9	60.4	66.5	75.2	81.2
		Ref. No.	1146.603	1146.604	1146.605	1146.606	1146.607	1146.608	1146.609	1146.610
	800	Weight [kg]	42.5	48.5	54.8	60.8	67.2	74.3	83.7	90.5
		Ref. No.	1148.603	1148.604	1148.605	1148.606	1148.607	1148.608	1148.609	1148.610
Extra charge per Stair guardrail		Weight [kg]	5.4	5.5	5.8	5.9	6.2	6.8	8.7	9.2
		Ref. No.	1160.603	1160.604	1160.605	1160.606	1160.607	1160.608	1160.609	1160.610

# ACCESSORIES

## ACCESSES



Alternative steps made of steel grating Slip resistance: R11		
Width [m]	0.60	0.80
Ref. No.	1151.601	1151.801

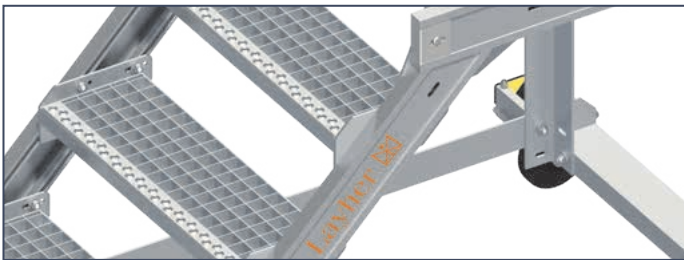

Alternative steps made of aluminium grating Slip resistance: R11		
Width [m]	0.60	0.80
Ref. No.	1151.602	1151.802

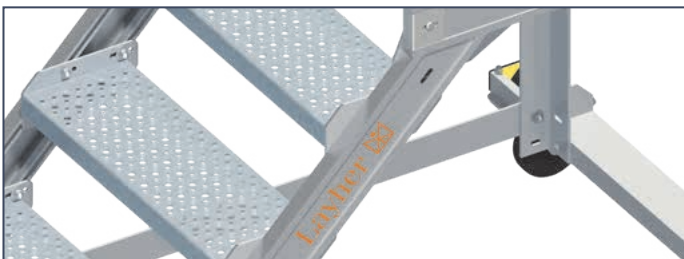

Alternative steps made of steel perforated plate Slip resistance: R11		
Width [m]	0.60	0.80
Ref. No.	1151.603	1151.803



Alternative steps made of aluminium perforated plate Slip resistance: R11		
Width [m]	0.60	0.80
Ref. No.	1151.604	1151.804



Wall bracket for supporting and fastening of aluminium stairs with platform	
Ref. No.	1171.000
To match:	Aluminium stairs with platform for step width 0.60 m



Wall bracket for supporting and fastening of aluminium stairs with platform	
Ref. No.	1172.000
To match:	Aluminium stairs with platform for step width 0.80 m

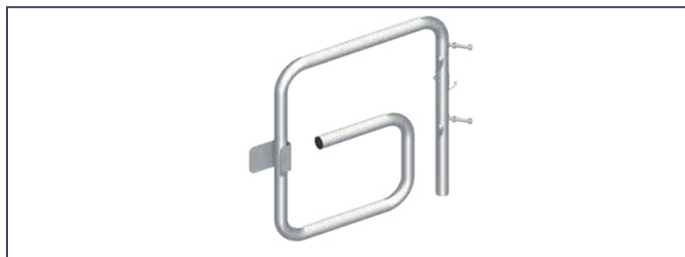

**Swing doors for installation where exits are open at the sides in the platform area**

Ref. No.	1153.502
To match:	Sides with step widths 0.60 m and 0.80 m



**Swing doors for installation where exits are open at the end in the platform area**

Ref. No.	1153.602
To match:	End with step width 0.60 m



**Swing doors for installation where exits are open at the end in the platform area**

Ref. No.	1153.802
To match:	End with step width 0.80 m



**Barrier chain for hanging across open exits**

Ref. No.	1153.601
To match:	End with step width 0.60 m, sides with step widths 0.60 m and 0.80 m
Ref. No.	1153.801
To match:	End with step width 0.80 m



Layher is your dependable partner with more than 75 years of experience. "Made by Layher" always means "Made in Germany" too – and that goes for the entire product range. Superb quality – and all from one source.

Proximity to the customer is a central factor behind Layher's success – geographically speaking too. Wherever our customers need us, we will be there – with our advice, assistance and solutions.

-  **SpeedyScaf**
-  **Allround Scaffolding**
-  **System-free Accessories**
-  **Protective Systems**
-  **Shoring**
-  **Event Systems**
-  **Rolling Towers**
-  **Ladders**
-  **Software**



Headquarters in Eibensbach



Plant 2 in Gueglingen

**Layher**   
 More Possibilities. The Scaffolding System.

**Wilhelm Layher GmbH & Co KG**  
 Scaffolding Grandstands Ladders  
 Ochsenbacher Strasse 56  
 74363 Gueglingen-Eibensbach  
 Germany

Post Box 40  
 74361 Gueglingen-Eibensbach  
 Germany  
 Telephone +49 (0) 71 35 70-0  
 Telefax +49 (0) 71 35 70-2 65  
 E-mail [export@layher.com](mailto:export@layher.com)  
[www.layher.com](http://www.layher.com)

